



2026

Siding Collection

Vinyl, Polymer, Composite,
Aluminum Siding & Stone
Veneer, Trim and Accessories



Welcome to the **2026** CertainTeed Siding Collection

Greater Rewards. Better Business.
The more you purchase, the more you earn, the more you succeed.



Why CertainTeed4

Choosing the Right Products.....8

2026 Highlights.....10

Icon Guide14

Composite Siding

RISE® Siding & Trim16

Reinforced Siding

CERTAplank®18

Reverse Board & Batten20

Aluminum Siding

Urban Reserve®22

Shakes & Shingles

Cedar Impressions®
Sawmill Shingles24

Cedar Impressions®
Perfection Shingles28

Cedar Impressions®
Perfection Shapes32

Cedar Impressions®
Rough-Split Shakes34

Northwoods®
Perfection Shingles, Rough Split
Shakes and Sawmill Shingles38

Insulated Siding

CedarBoards™/ XL42

Horizontal & Vertical Siding

Board & Batten Vertical Siding46

Monogram®/ XL48

Restoration Classic™52

Carolina Beaded™56

MainStreet™58

American Legend™62

Encore™64



CertainTeed offers the industry’s most comprehensive selection of cladding options. From siding to trim to accent marks, like STONEfaçade, your customers have the freedom to express their unique style. Our portfolio sets the standard for beauty, performance, and choice.

With CertainTeed, your customers can mix, match, and create beyond the boundaries of traditional design with a wide range of colors, textures, and designs. Between your guidance and our products, they’ll have a house they’re proud to call home.

For professionals, higher standards mean stronger support. We bring over 120 years of experience to help you navigate the market with confidence—offering training, certifications, rebates, contractor cash back, and marketing tools to help you stand out and grow.

Grow your business and earn rewards by helping customers transform their homes with premium roofing, siding, and trim from CertainTeed.

Join our Contractor Loyalty Program, the most robust in the industry, to gain access to top-tier training, sales and marketing resources, and visibility through our “Find a Pro” tool. No other program is more committed to your success. As a business, and partner.

**Our success
is tied to your
success.**

Stone Veneer

STONEfaçade®66

Vinyl and Aluminum Soffit / Porch Panel

Invisivent® Triple 3-1/3"70

Perimeter™ Triple 3-1/3"70

Beaded70

Ironmax™72

Universal72

Value73

Aluminum Triple 4"74

Aluminum Quad 4"74

Aluminum Accessories.....75

Trim

Vinyl Carpentry®76

Restoration Millwork®78

Finishing Touches80

Weatherproofing

Housewrap & Flashing Tape82

Colors shown throughout this brochure are as accurate as printing methods will permit. Please see product samples before making final selection. Materials of differing gloss level, texture, composition and orientation can look different despite being the same color, it is important to get samples of every product being considered and place them where they will be installed.

On Cover:

Siding: Board & Batten S7" in Smoky Gray and Monogram Double 5" Clapboard in Natural Clay.

Trim: Vinyl Carpentry®.

Why CertainTeed?

Trust

Professionals agree, CertainTeed still leads the Vinyl and Polymer Siding industry

Year after year, builders and contractors named CertainTeed Vinyl Siding Number One in the categories: Brand Familiarity; Brands Used in the Past Two Years and Brands Used Most.



CertainTeed offers an industry-leading spectrum of colors including unique darker shades and semi-transparent stained colors for virtually unlimited design possibilities.

Utilizing the newest technology and state-of-the-art formulations, CertainTeed backs their vinyl siding with PermaCOLOR Lifetime Fade Protection.

Warranty

Simply put, if our product fails due to a manufacturing defect, we will stand behind it. To obtain a copy of our complete warranty go to www.certainteed.com

Service

Local Manufacturing

CertainTeed's building products are shipped from manufacturing facilities throughout United States and Canada, ensuring that you are rarely far from a factory location.

Professional Distributors

Our strong network of local distributors enables you to rest easy knowing that you will have complete access to CertainTeed's full line of exterior products.

Experienced Territory Managers

With over 250 territory managers across North America, it is easy to find a CertainTeed representative who can assist you in growing your business.

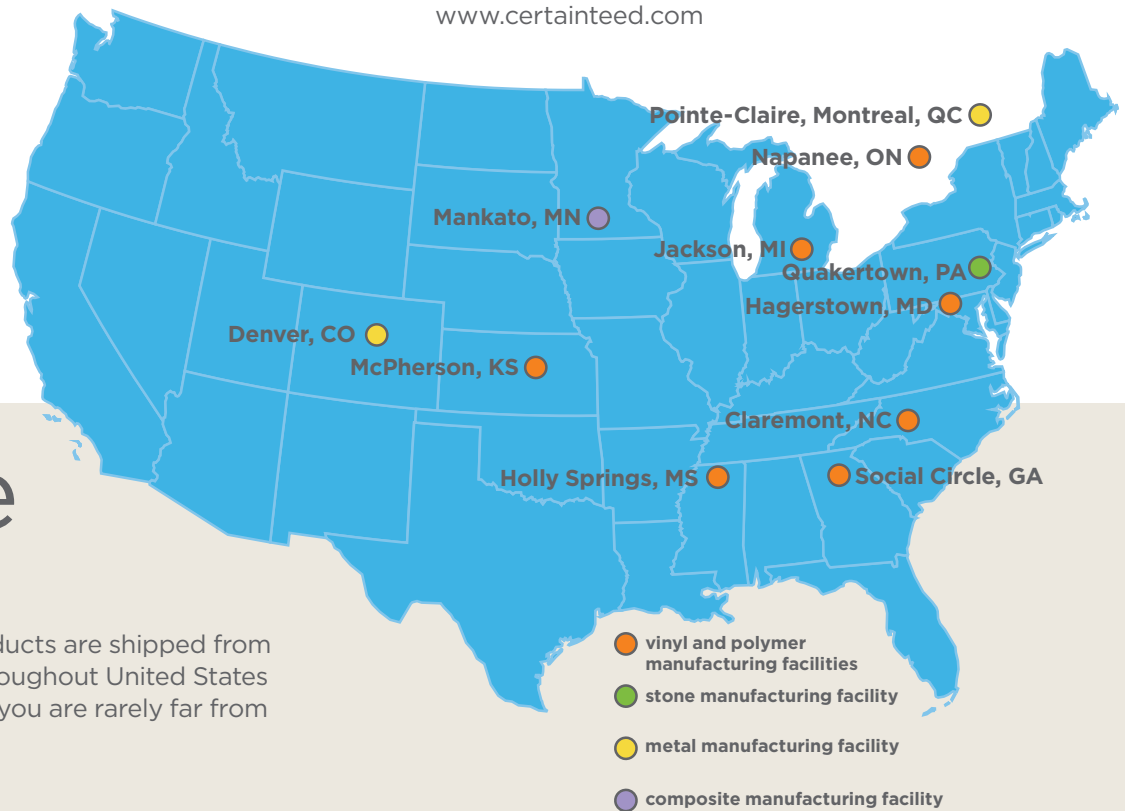

Mobile Training Vehicles



Expert Training and Education

Each year CertainTeed travels across North America putting on over 200 local training programs designed to help you increase your skills, capabilities and profit potential.

Mix & Match

Benefit from the power to mix & match products, styles and colors

CertainTeed's complete selection of exterior product options are tailor-made to take creative advantage of the exciting mix-and-match approach to exterior home design - combining various products, styles and colors to create truly unique exterior designs.

Using combinations of horizontal and vertical siding plus shakes and shingles together makes a bold statement. Adding soffit and trim delivers just the right accent. The collection allows your customers to rely on a single, trusted source for virtually every exterior product they need - and gives you more opportunities to cross-sell.



SABLE BROWN

COLONIAL WHITE

SAVANNAH WICKER

AUTUMN RED



SMOKY GRAY

COLONIAL WHITE

STERLING GRAY

STERLING GRAY

CHARCOAL GRAY

Why CertainTeed?

Color Leadership

Together, siding, trim and roofing color selection has a profound impact on the overall look of a home's exterior. Siding and trim colors cover the exterior walls for curb appeal, but this also extends to the roofline, on what one architect calls a home's "fifth façade."

CertainTeed's color alignment simplifies the task of combining siding and roofing with other facets of the overall design to create a cohesive look. From warm and inviting to cool and fresh, there are color palettes to satisfy every preference. All our products deliver the craftsmanship, durability and virtually maintenance-free performance your customers expect from CertainTeed.

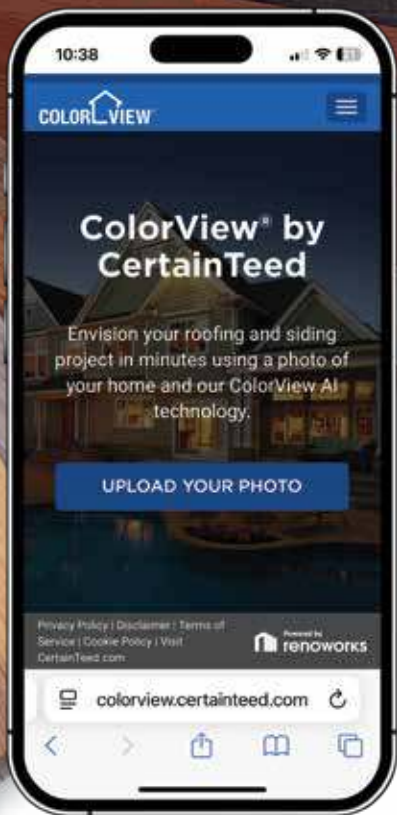

ColorView® visualizer offers users the ability to mix and match the many colors and styles of CertainTeed roofing and siding directly on their own homes to create beautiful designs and inspire new ideas. Utilizing our AI software, users' homes are uploaded, processed, and ready to visualize in less than 30 seconds - for free!

For those who don't want to upload a photo of their own home, our pre-rendered Design Templates include 25 unique home styles for users to get started with their design projects as easily as possible.



Visualize your home in less than a minute today at colorview.certainteed.com

ColorCoach™ is a web-based tool that helps provide some basic education on color theory and helps provide some recommended color combinations for the consumer audience. It also helps contractors and builders recommend CertainTeed roofing, siding, and trim color combinations that look great together.

Colors shown throughout this brochure are as accurate as printing methods will permit. Please see product samples before making final selection. Materials of differing gloss level, texture, composition and orientation can look different despite being the same color, it is important to get samples of every product being considered and place them where they will be installed.

Innovation

TrueTexture™

CertainTeed was the first to produce siding utilizing a direct transfer system from real cedar boards, shingles and shakes to create natural TrueTexture finishes. The look of true wood craftsmanship can be created when combined with CertainTeed's Vinyl Carpentry® and Restoration Millwork®.

Installation Features

Many engineering innovations including SureStop™, EasyMeasure™, PanelThermometer™, HammerTapper™ and StudFinder making CertainTeed Siding the industry leader.

Cedar Impressions patented **PanelThermometer™** and temperature lines are designed to ensure precise installation.

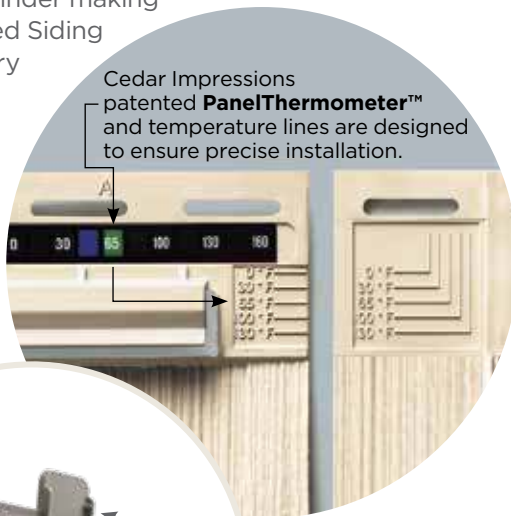

HammerTapper™
Enables lateral adjustment for easier siding panel installation.

EasyMeasure™

SureStop™
Recessed nailing area.

STUDfinder™

Designed for all CertainTeed panels and Housewrap to help ensure a safe, precise installation for maximum siding performance.



16"

RISE Siding & Trim Composite Siding

The patented manufacturing process compresses reclaimed synthetic fiber and polymer materials into dense and durable wood replacement products that come in smooth and woodgrain finishes.

Protective Water Barrier
(top and bottom)

Short Synthetic Fibers

Long Synthetic Fibers

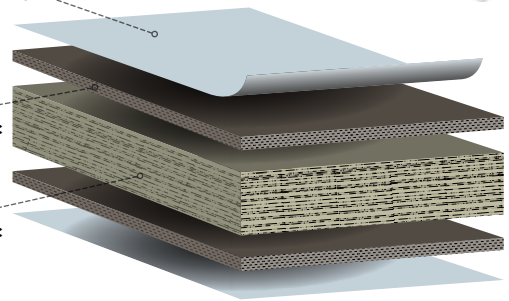

STONEfaçade Patented technology

Fully-integrated rainscreen, and a fastening flange that is designed to provide ease of installation.

Fully-integrated rainscreen

A 3/8" steel insert embedded into each panel allows top-to-bottom drainage that protects walls from moisture build-up, and reduces the potential for moisture-related issues.

Beveled perimeter

Improves overall fit and finish for an uninterrupted appearance along the length of the wall.

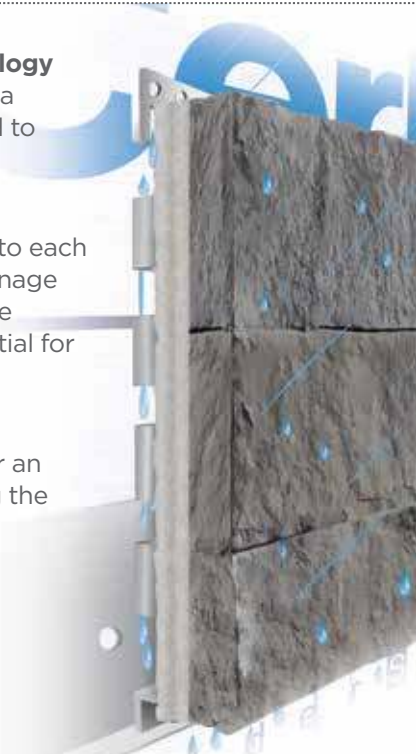

Choosing the right products for your project.

Curb Appeal™ That Lasts

CertainTeed offers an industry-leading selection of low-maintenance products that create beautiful, timeless looks that last.

Authentic from the curb or close up

From historic to modern to timeless, each project has its own unique design challenges. CertainTeed's wide variety of styles and textures empower you to select the product that will deliver the architectural accuracy and beauty required to meet every project's needs.



Industry leading color palette

CertainTeed's color palette simplifies the task of combining siding and roofing with other facets of the overall design to create a cohesive look. From warm and inviting to cool and fresh, there are color palettes to satisfy every preference. Backed by PermaColor™ Lifetime Fade Protection, our products deliver the virtually maintenance-free performance your customers expect.



Details create the personality

The personality of a home is reflected in the unique details of the project. CertainTeed offers a complete selection of virtually maintenance-free accent and decorative trim accessories designed to complement any project.





Perform. Protect. Preserve.

RISE Siding and Trim products are designed for demanding jobs. Quality synthetic fibers such as polyester, nylon, and fiberglass are core ingredients that result in affordable, durable, and long-lasting siding and trim options. These fibers come from post-consumer and post-industrial recycle and waste streams making RISE a forward-looking alternative to cement, and wood-based products.



A modern look that provides a unique touch to any exterior

Urban Reserve® Aluminum Siding and Soffit comes in versatile colors and textures that bring style and sophistication to any design. Combine with other materials and finishes to highlight a home's focal point or use it all over for a fresh and striking look. Choose from 9 fade-resistant solid colors and 6 woodgrain colors.



The timeless look of stone

Nothing says "Welcome home" like the warm and inviting look of stone. Take your home's exterior to a new level with CertainTeed STONEfaçade, a manufactured architectural stone veneer that delivers the beauty and craftsmanship of natural stone in an affordable, durable, and easy-to-install panelized system.

2026 Highlights

New Product and Color Releases



RISE[®] Siding & Trim Composite Siding

Look/Feel of Wood: You can cut, install and handle RISE siding and trim like traditional wood because RISE mimics natural wood's simplicity and flexibility, but without the associated cost and maintenance. No special tools needed.

Page 16

Ground Contact & Moisture Resistance: RISE products withstand heavy rain and snow while defying freeze/thaw damage and resisting rot. RISE siding and trim products are also the only hard siding products on the market that allow for incidental ground contact.

Easy to Handle: With less breakage and no special tools required, you can save time and reduce jobsite waste. RISE is also the only exterior siding product available in 13' 4" (160") lengths, making it the perfect length for 16" on center stud spacing.

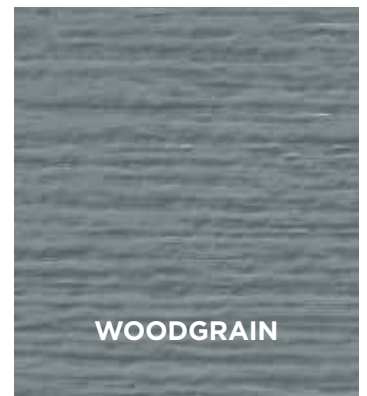

All products available in both woodgrain and true smooth finishes.

94% Recycle Content: RISE products are created with 94% recycled materials. By reclaiming the high performance synthetic fibers and polymers, we were able to engineer a durable siding solution that reduces the need to landfill these materials.

30-Year Warranty: RISE products are backed by a 30-year substrate limited warranty.

RISE siding and trim is available in primed or pre-painted finishes. Product sizes and pre-finish color availability varies by region.

REACH FOR RISE

RISE comes in several profiles and sizes, perfect for your next project.
Check the Siding product catalog (04-08-30-US-EN) for all sizes and specifications.

Panel Siding



Smooth



Woodgrain

Lap Siding



Smooth



Woodgrain

Trim Boards



Smooth



Woodgrain

Corner



Woodgrain only

RISE Siding and Trim is available primed or prefinished. Product sizes and prefinished color availability varies by region. Please work with your local supplier for options and availability.

Prefinished colors (available in smooth or woodgrain)



Melrose



Tuxedo



Slate



Sable Brown

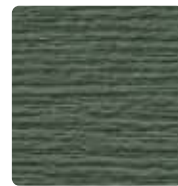

Forest

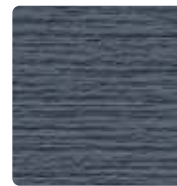

Midnight Blue



Pacific Blue



Flagstone



Smoky Gray



Charcoal Gray



Castle Stone

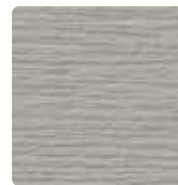

Granite Gray



Sterling Gray



Seagrass



Cypress



Herringbone

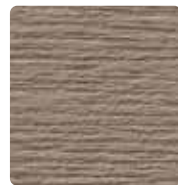

Weathered Wood

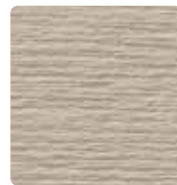

Natural Cay

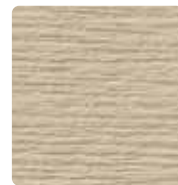

Savannah Wicker



Colonial White

2026 Highlights

New Product and Color Releases

Urban Reserve[®] Aluminum Siding



All new woodgrain colors feature a premium, fade-resistant PVDF finish engineered to withstand extreme heat and weather, ensuring long-lasting beauty and superior protection.

Page 22

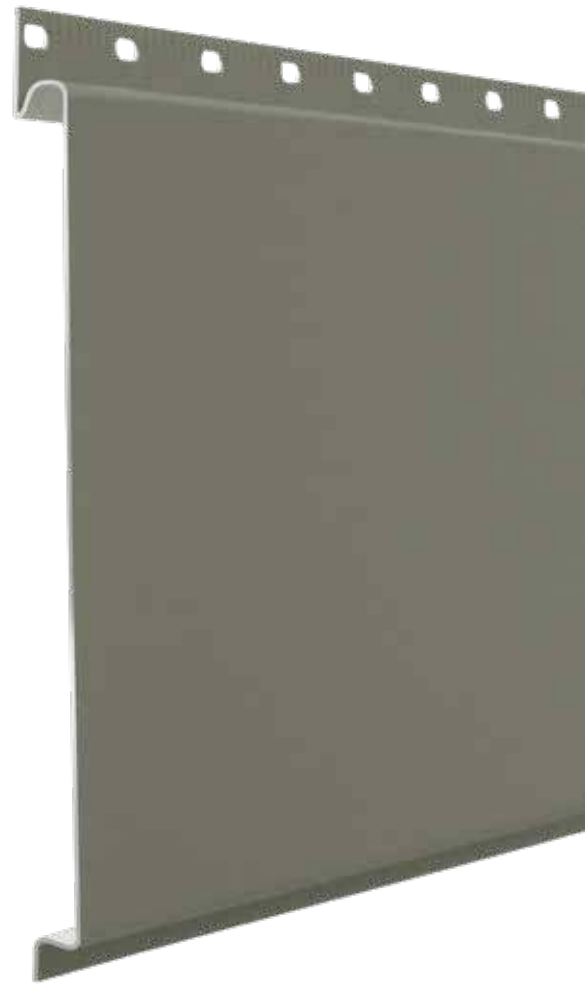

Woodgrain colors



Gothic Gray



Soho Gray



Harvest Cedar



Rockwood



Loft Blonde

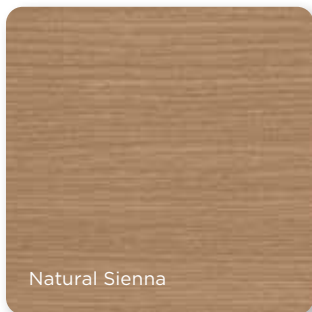

Natural Sienna

Solid colors

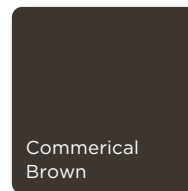

Commerical Brown

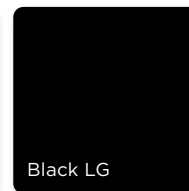

Black LG

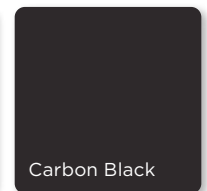

Carbon Black

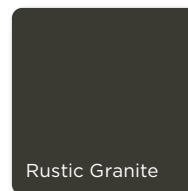

Rustic Granite



Brushed Pewter



Charcoal Ash



Grafton Grey

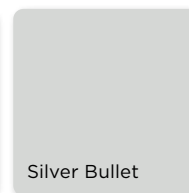

Silver Bullet

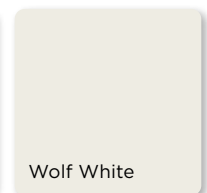

Wolf White

CERTApLank[®]

Reinforced Siding



Melrose and Tuxedo have been added to the CERTApLank line.

Page 18



STONEfaçade[™]



New color introductions for STONEfaçade include Acadia Breeze, Shenandoah Ridge, and trim accessory color Greige.

Page 66



Acadia Breeze



Shenandoah Ridge

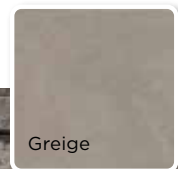

Icon Guide

Below you will find an explanation of each icon used for easy reference to identify and compare the many product features, benefits and specifications of the siding products offered by CertainTeed.

Aesthetics



Colors:

Shows the number of different colors available within each product line. The CertainTeed Siding Collection features solid colors that replicate the look of freshly painted cedar and variegated blends which provide the appearance of semi-transparent stained finish.



Extended Lengths:

Indicates products that are available in extended lengths, including 16', 20' and 25'. Longer length siding significantly reduces the number of seams when panels overlap horizontally, increasing the overall aesthetics of the wall.



Panel Projection:

Identifies the full depth of a siding panel as measured from the back of the panel to the tip of the front of the panel. Deeper panel projections add rigidity to siding products while providing wider shadow lines that enhance aesthetics. This measurement is also used for proper sizing of accessories necessary to install the siding.



Profiles:

Lists the number of different profiles available within each product line. A profile is the contour or outline of a panel as viewed from the side or end. Product profiles, such as clapboard and dutchlap, are designed to mimic the different architectural styles of wood or stone cladding products.



Texture:

Indicates available textures within each product line. Whether you are seeking the smooth appearance of milled cedar, or one of the many TrueTexture™ woodgrains molded from real cedar boards, CertainTeed offers a wide array of architecturally authentic product textures to choose from.

Installation



Fastener Indicator:

CertainTeed is the only siding engineered to include an integral fastener placement guide on each panel. The Patented STUDfinder™ Installation System and Cedar Impressions® fastener indicators are designed to help ensure a safe, precise installation for maximum siding performance.



Lock:

Designates the panel lock design of the product. CertainTeed Siding Products feature proprietary locking designs created to optimize the alignment and installation for each specific product. The special features of CertiLock™ and DuraLock® ensure that every siding panel goes on the wall straight and secure.

Performance



Drainability / Moisture Resistance:

Product technology eliminates the common problem of moisture accumulation in wall cavities through the use of innovative materials, rainscreens, weep holes or open designs.



Fade Protection:

CertainTeed offers an industry-leading spectrum of colors including unique, darker shades and semi-transparent stained blends for virtually unlimited design possibilities. Utilizing a unique pigment chemistry, CertainTeed guarantees Lifetime Fade Protection on our vinyl siding.



Fastening Hem Design:

Identifies the type of fastening hem design on a cladding product. Rollovers and / or reinforcing ribs are used to stiffen the nail hem of a siding panel, giving it a straighter appearance on the wall while contributing to the wind load resistance of the product.



Flame Spread Rating:

Indicates products that are Class A Flame Spread Classified, meaning that the material is highly resistant to fire and does not spread flames quickly and/or is self-extinguishing.



Low Maintenance:

Unlike other cladding products that require regular repainting, recaulking, tuck-pointing, and sealing to maintain their aesthetics, CertainTeed cladding products can be kept beautiful using a soft bristle brush and a bucket of soapy water.



Panel Thickness:

Defines the average thickness or gauge of a siding panel which is an important element of siding quality. Thicker panels look straighter on the wall, are more durable, and hold up against impacts and high winds. CertainTeed siding products are regularly audited by Architectural Testing, Inc. to ensure they meet or exceed ASTM standards for vinyl siding.



Warranty:

CertainTeed shakes, shingles, insulated, horizontal, soffit and vertical products are covered by a Lifetime Limited Warranty.



Wind Load:

This is the rating for the maximum wind pressure that a siding product can withstand. All CertainTeed Siding products* are rigorously tested by Intertek Group plc. to meet or exceed ASTM standards for resistance to negative wind load pressures.

*Products adhere to ASTM D3679, D7793, D7254 standards for capable wind speed ratings based on standard wind load design pressure ratings. For most current ratings, please reference www.certainteed.com.

Colors shown throughout this brochure are as accurate as printing methods will permit. Please see product samples before making final selection. Materials of differing gloss level, texture, composition and orientation can look different despite being the same color, it is important to get samples of every product being considered and place them where they will be installed.

RISE® Siding & Trim

Composite Siding

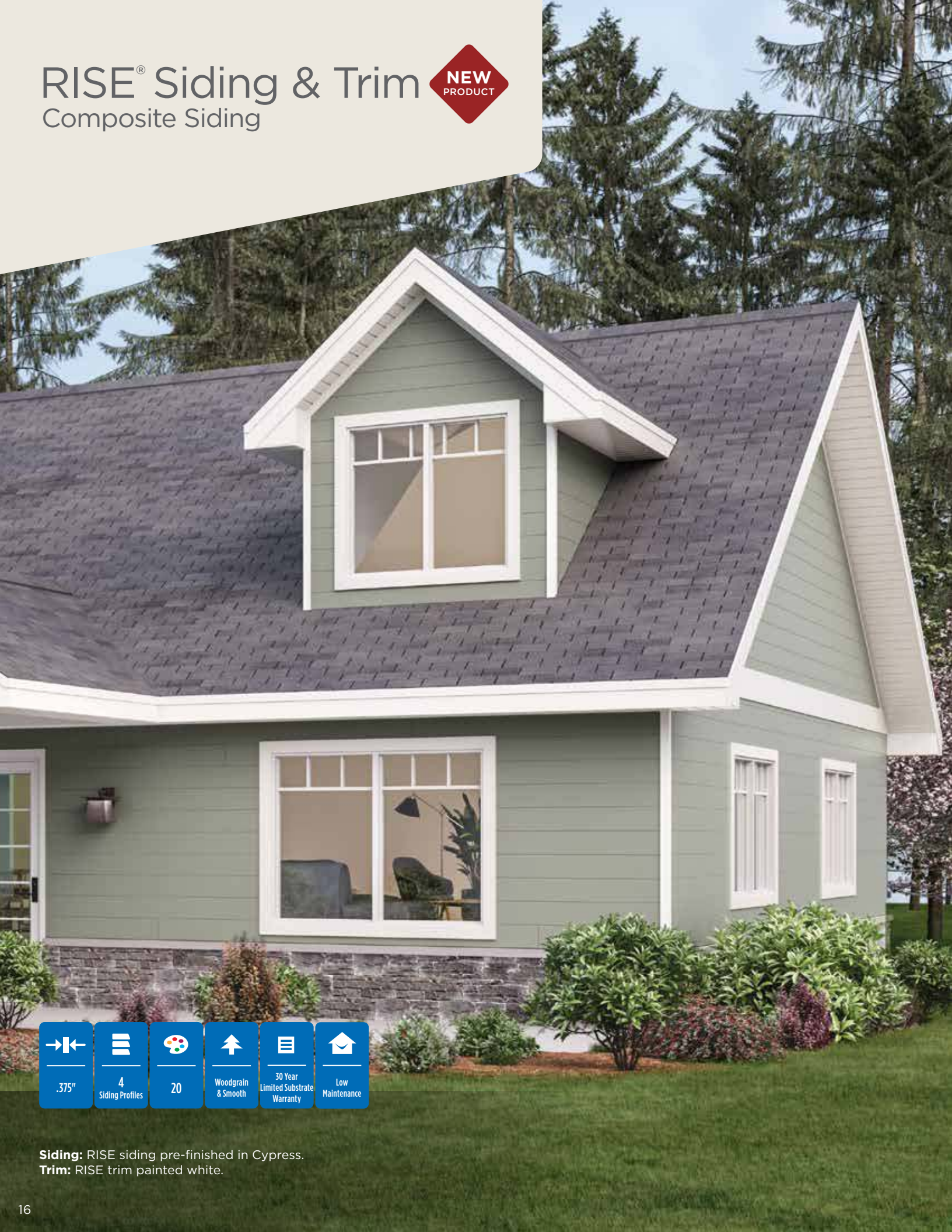

.375"



4
Siding Profiles



20



Woodgrain
& Smooth



30 Year
Limited Substrate
Warranty



Low
Maintenance

Siding: RISE siding pre-finished in Cypress.
Trim: RISE trim painted white.

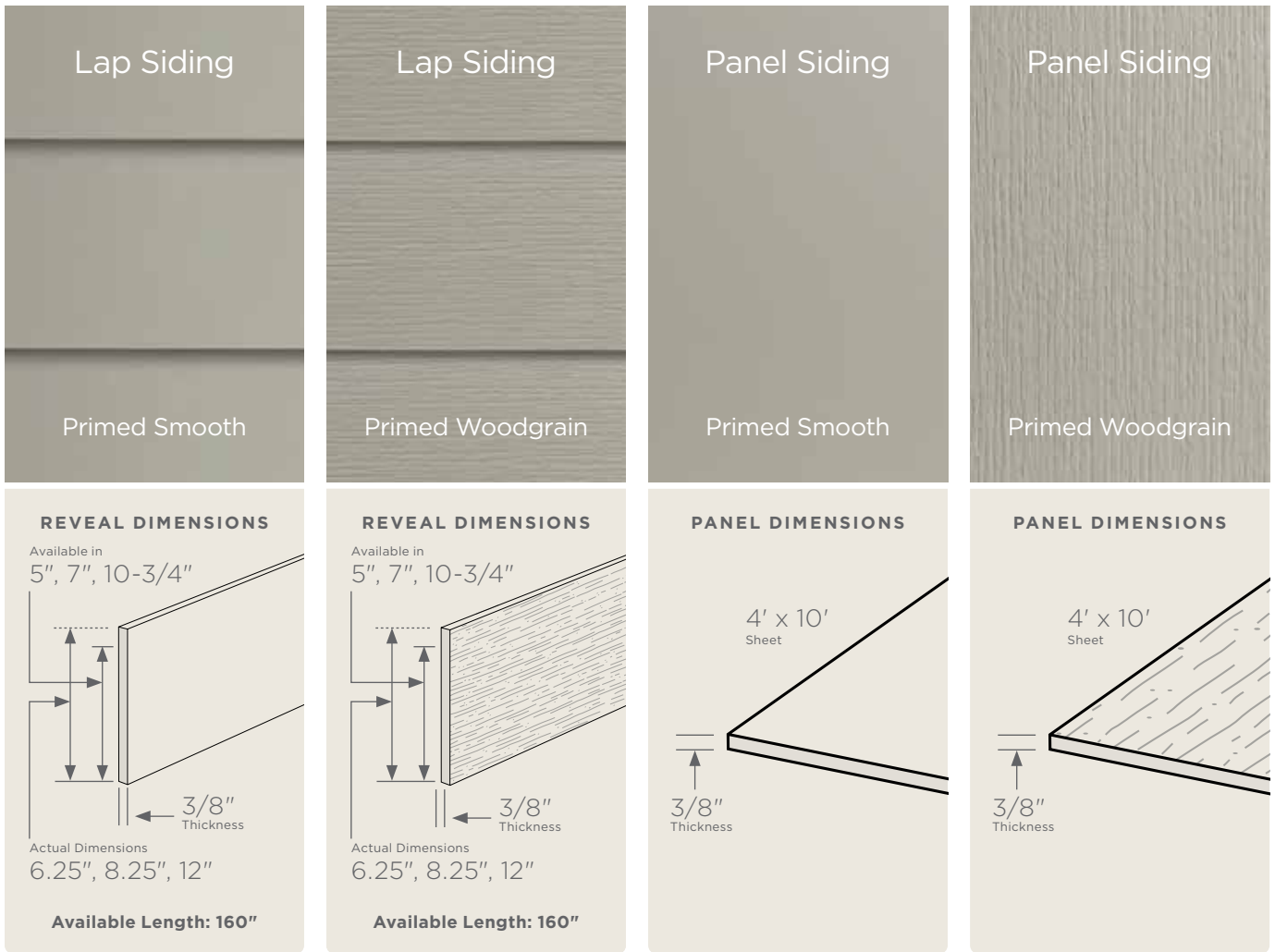

- Looks, feels and installs like real wood
- Minimal expansion and contraction
- No decay, rot or freeze/thaw damage
- Available primed and pre-finished
- 30-Year Warranty

All siding and trim products available in both woodgrain and true smooth finish, primed or pre-painted finishes below.

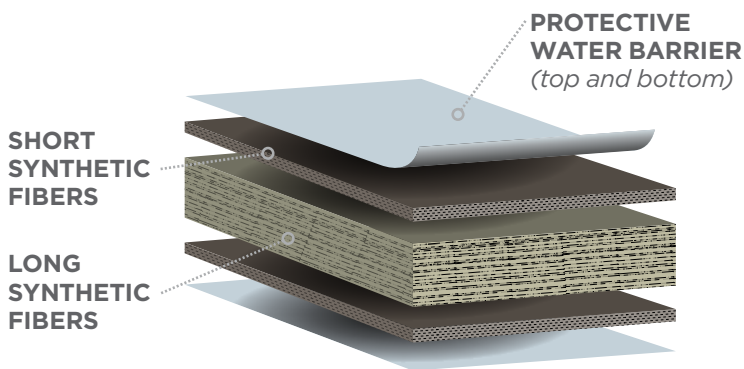

The patented manufacturing process compresses reclaimed synthetic fiber and polymer materials into dense and durable wood replacement products that come in smooth and woodgrain finishes.









Primed
Melrose
Tuxedo
Slate
Sable Brown
Forest
Midnight Blue
Pacific Blue
Flagstone
Smoky Gray
Charcoal Gray
Castle Stone
Granite Gray
Sterling Gray
Seagrass
Cypress
Herringbone
Weathered Wood
Natural Clay
Savannah Wicker
Colonial White

Consult the Product Catalog (04-08-30-US-EN) for all available RISE Siding and Trim products.

CERTApLank[®]

Reinforced Siding



- 
.046"
- 
1
- 
17
- 
Partial Rollover Nail Hem
- 
3/4" Panel Projection
- 
Woodgrain
- 
Post-Formed Positive Lock
- 
Lifetime Limited Warranty
- 
Class A Flame Spread
- 
STUDfinder
- 
PermaColor Fade Protection
- 
Low Maintenance

Siding: CERTApLank Single 7" Clapboard in Flagstone.
Trim: Vinyl Carpentry[®], Restoration Millwork[®] and Mounting Blocks.

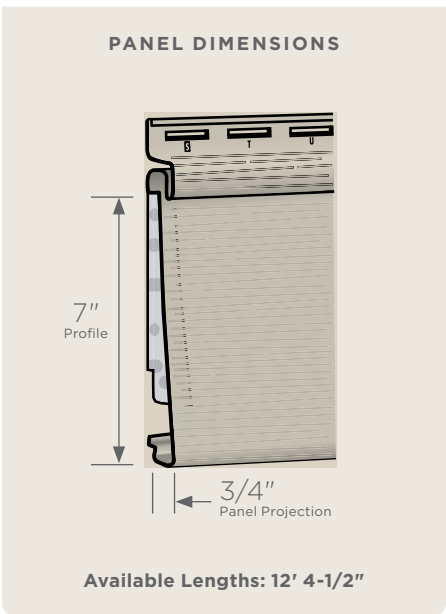
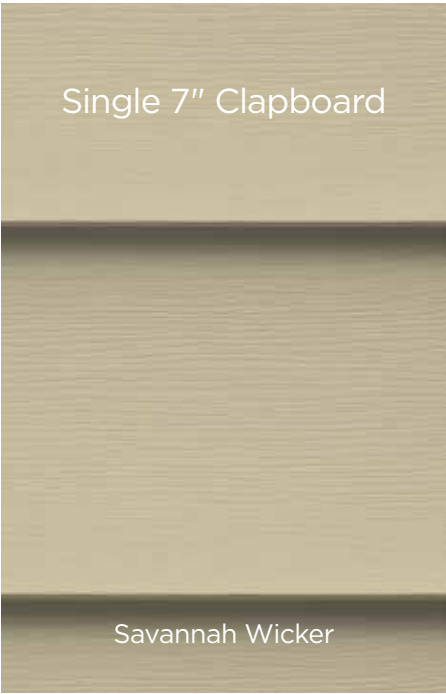

No unsightly gaps on finished walls



* Deluxe Colors

NEW COLOR	Melrose*	●
NEW COLOR	Tuxedo*	●
	Sable Brown*	●
	Forest*	●
	Midnight Blue*	●
	Pacific Blue*	●
	Wedgewood Blue	●
	Flagstone*	●
	Smoky Gray	●
	Charcoal Gray*	●
	Castle Stone	●
	Granite Gray	●
	Sterling Gray	●
	Herringbone	●
	Natural Clay	●
	Savannah Wicker	●
	Colonial White	●

S7 Clapboard



Reinforced Foam Backer →
 Combined with an extra thick panel to create rigidity and durability you'd expect from a hardboard cladding.

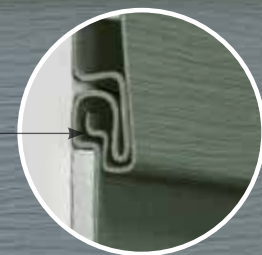





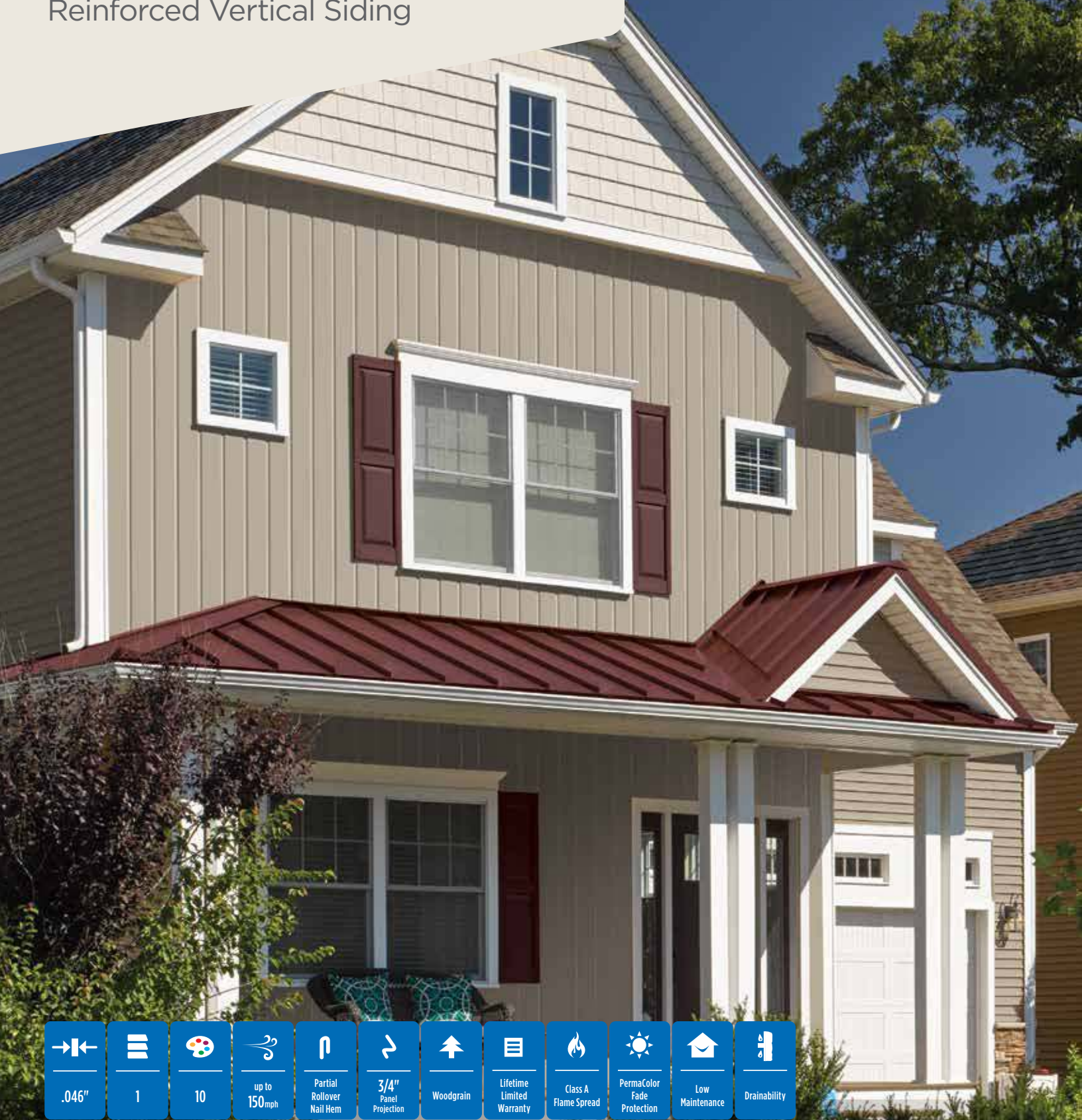

Single 7" Woodgrain Clapboard

Reverse Board & Batten

Reinforced Vertical Siding



-  .046"
-  1
-  10
-  up to 150_{mph}
-  Partial Rollover Nail Hem
-  3/4" Panel Projection
-  Woodgrain
-  Lifetime Limited Warranty
-  Class A Flame Spread
-  PermaColor Fade Protection
-  Low Maintenance
-  Drainability

Siding: Reverse Board & Batten Single 7" Reinforced Vertical Siding and Restoration Classic Double 4-1/2" Natural Clay, Cedar Impressions Double 7" Straight Edge Perfection Shingles in Herringbone with Ironmax Double 5" Vented Soffit in Colonial White.
Trim: Vinyl Carpentry® & Restoration Millwork®.

Single 7" Reinforced Vertical Siding

Midnight Blue

PANEL DIMENSIONS

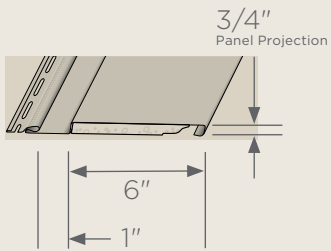

Available Length: 10'

* Deluxe Colors

Autumn Red*	●
Sable Brown*	●
Midnight Blue*	●
Pacific Blue*	●
Charcoal Gray*	●
Granite Gray	●
Sterling Gray	●
Natural Clay	●
Savannah Wicker	●
Colonial White	●

S7 Reverse Board & Batten



Reinforcing foam



Urban Reserve[®]

Aluminum Siding



.027"	1	15	2/5" Panel Projection	Smooth	40 Year Warranty	Low Maintenance	Class A Flame Spread

Siding: Urban Reserve Single 6" Panel in Charcoal Ash.
Soffit: Urban Reserve soffit in Charcoal Ash.

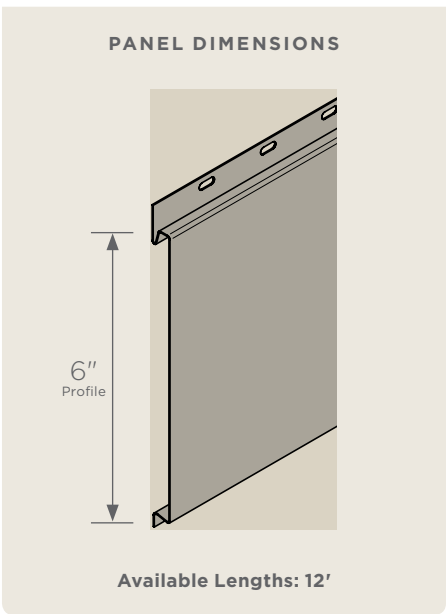
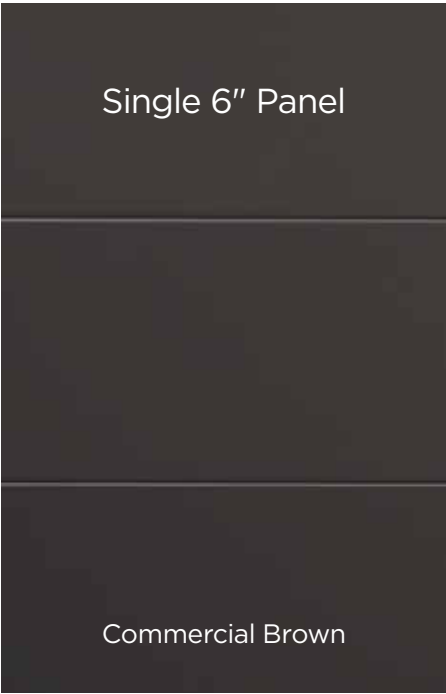

Matching Soffit, Accessories, and Trim Coil available.

Aluminum Soffit

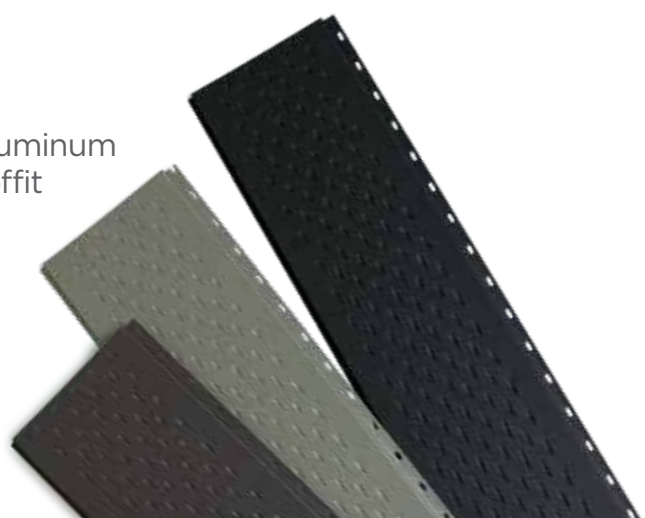

** Premium Colors
* Deluxe Colors



Gothic Grey**	●
Soho Grey**	●
Harvest Cedar**	●
Rockwood**	●
Loft Blonde**	●
Natural Sienna**	●
Commercial Brown	●
Black LG	●
Carbon Black	●
Rustic Granite	●
Brushed Pewter	●
Charcoal Ash	●
Grafton Grey	●
Silver Bullet*	●
Wolf White	●









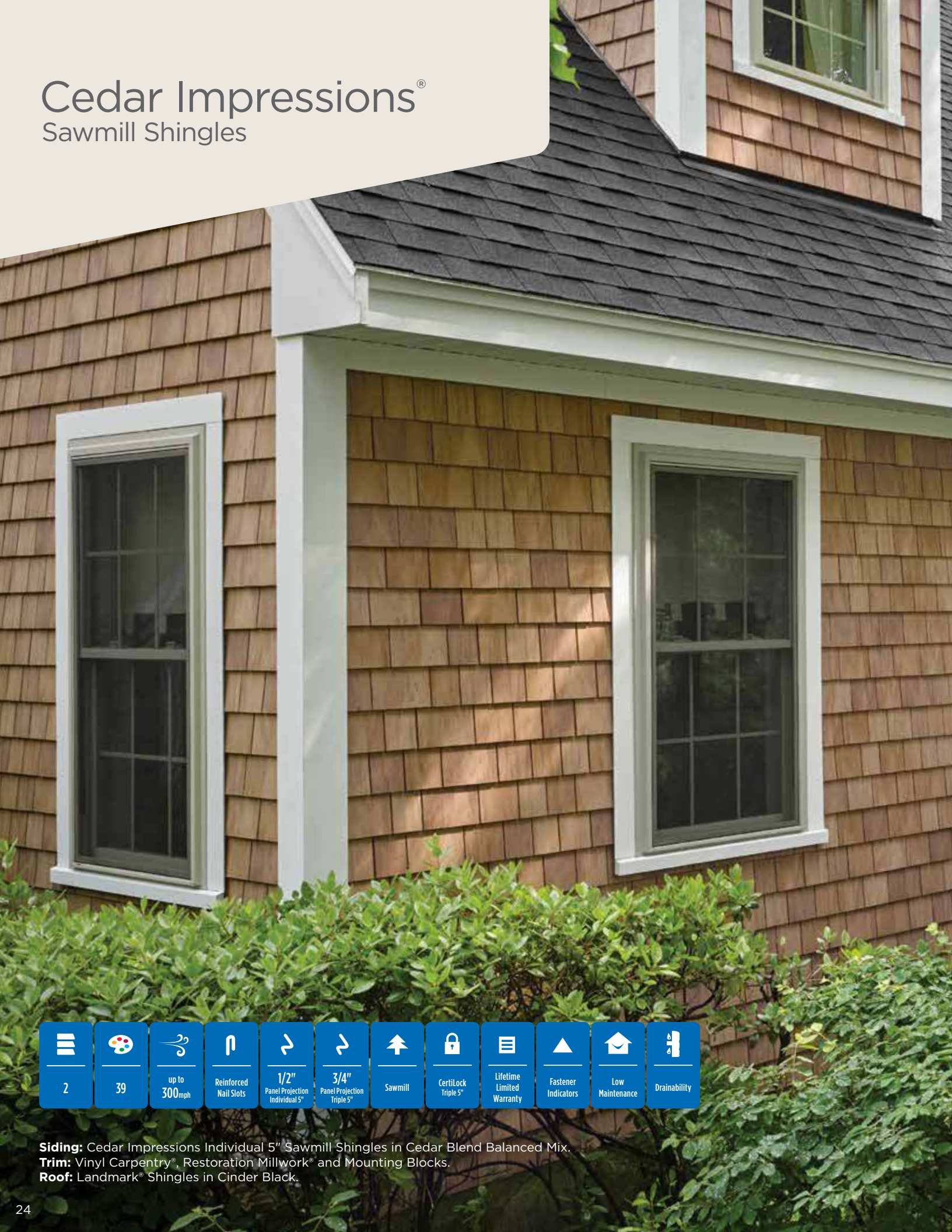

S6 Panel



Cedar Impressions®

Sawmill Shingles



-  2
-  39
-  up to 300mph
-  Reinforced Nail Slots
-  1/2" Panel Projection Individual 5"
-  3/4" Panel Projection Triple 5"
-  Sawmill
-  CertiLock Triple 5"
-  Lifetime Limited Warranty
-  Fastener Indicators
-  Low Maintenance
-  Drainability

Siding: Cedar Impressions Individual 5" Sawmill Shingles in Cedar Blend Balanced Mix.
Trim: Vinyl Carpentry®, Restoration Millwork® and Mounting Blocks.
Roof: Landmark® Shingles in Cinder Black.



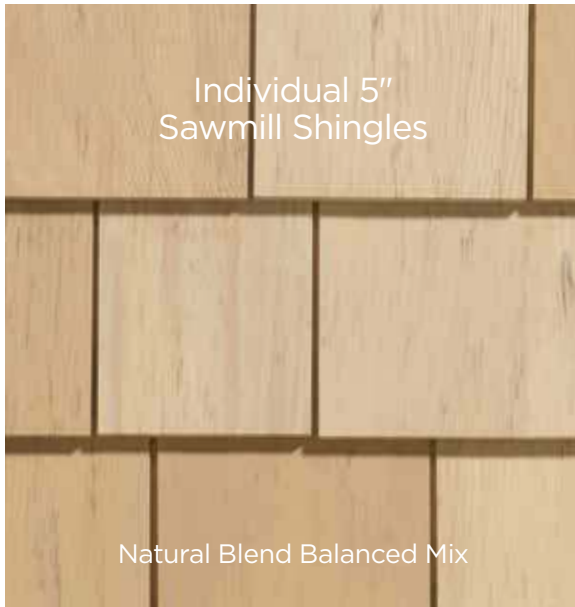

Individual 5"
Sawmill Shingles

Natural Blend Balanced Mix

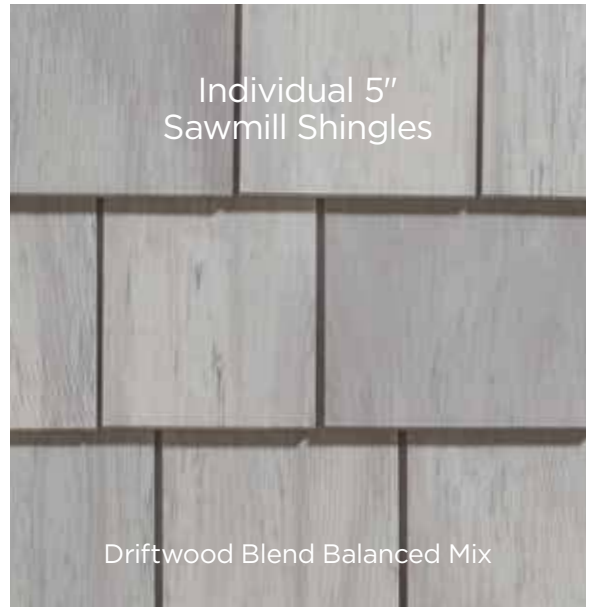

Individual 5"
Sawmill Shingles

Driftwood Blend Balanced Mix

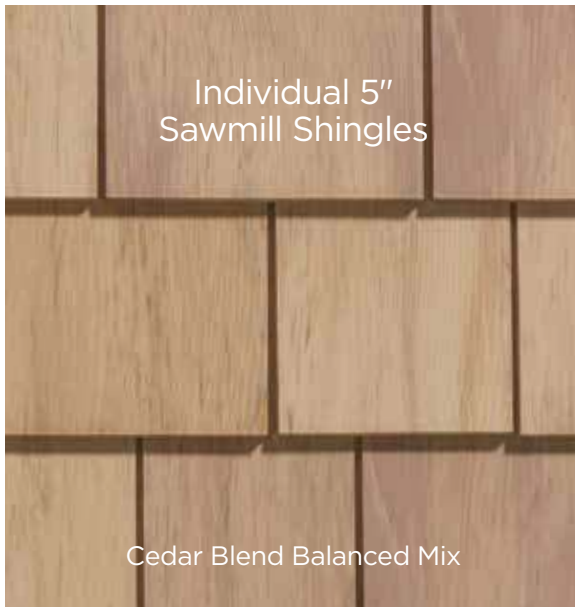

Individual 5"
Sawmill Shingles

Cedar Blend Balanced Mix



Individual 5"
Sawmill Shingles

Rustic Blend Balanced Mix

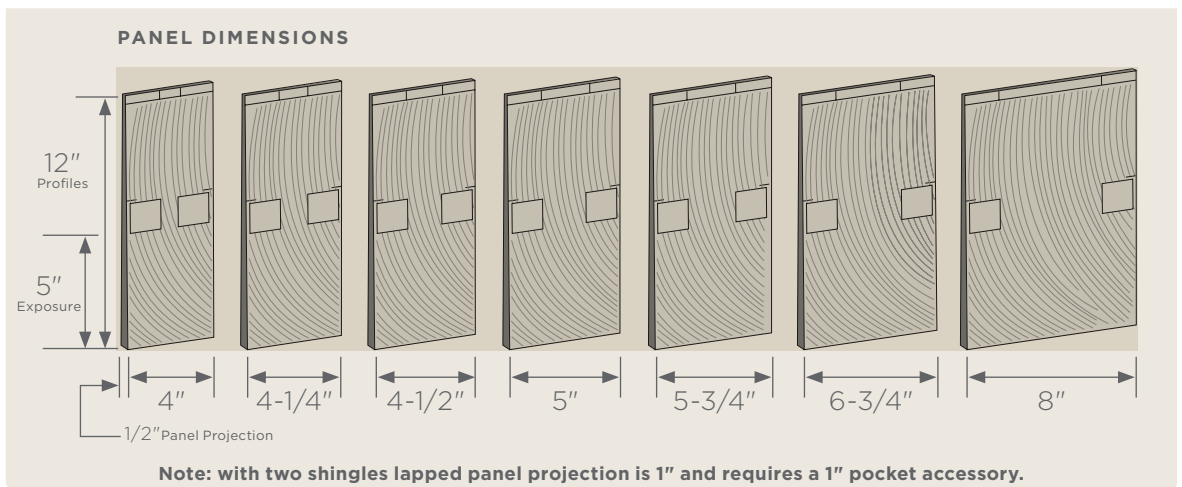

Recommended Trim

CertainTeed recommends the use of Restoration Millwork PVC trim for the most authentic look of genuine cedar. If you choose to use CertainTeed vinyl accessories, the following solid colors are the best comparable options:

- Natural Blend = Buckskin
- Cedar Blend = Cedar Blend Solid
- Driftwood Blend = Granite Gray or Charcoal Gray
- Rustic Blend = Sable Brown



Triple 5"
Sawmill Shingles

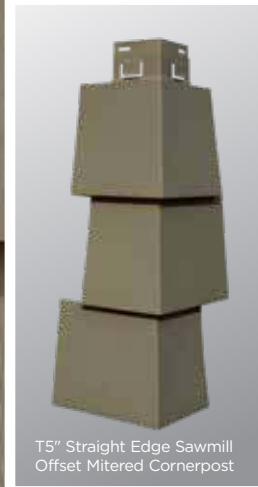

T5 Straight Edge Sawmill
Offset Mitered Cornerpost

Hearthstone

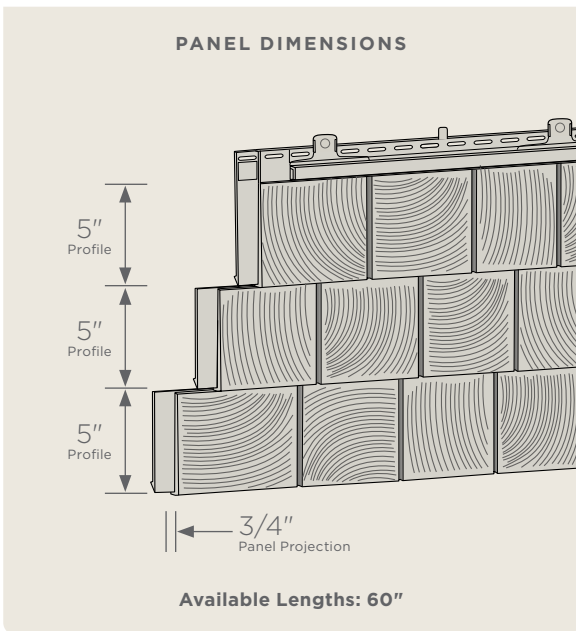













** Premium Colors

	I5 Sawmill Shingles	T5 Sawmill Shingles
Natural Blend – Light**	●	
Natural Blend – Medium**	●	
Natural Blend – Dark**	●	
Driftwood Blend – Light**	●	
Driftwood Blend – Medium**	●	
Driftwood Blend – Dark**	●	
Cedar Blend – Light**	●	
Cedar Blend – Medium**	●	
Cedar Blend – Dark**	●	
Rustic Blend – Light**	●	
Rustic Blend – Medium**	●	
Rustic Blend – Dark**	●	
Brownstone		●
Autumn Red		●
Slate		●
Espresso		●
Sable Brown		●
Sparrow		●
Hearthstone		●
Spruce		●
Forest		●
Midnight Blue		●
Pacific Blue		●
Wedgewood Blue		●
Flagstone		●
Charcoal Gray		●
Castle Stone		●
Granite Gray		●
Graystone		●
Sterling Gray	●	●
Seagrass	●	●
Cypress		●
Herringbone		●
Desert Tan		●
Weathered Wood		●
Natural Clay	●	●
Savannah Wicker	●	●
Heritage Cream		●
Colonial White	●	●

Cedar Impressions®

Perfection Shingles



- 
3
- 
38
- 
up to 200mph
- 
Reinforced Nail Slots
- 
3/4" Panel Projection
- 
Perfection
- 
Molded Perimeter Lock
- 
CertiLock Continuous Hanger
- 
Lifetime Limited Warranty
- 
Fastener Indicators
- 
Low Maintenance
- 
Drainability

Siding: Cedar Impressions Double 7" Straight Edge Perfection Shingles in Seagrass.
Trim: Vinyl Carpentry® & Restoration Millwork®.
Roof: Highland Slate in Fieldstone.



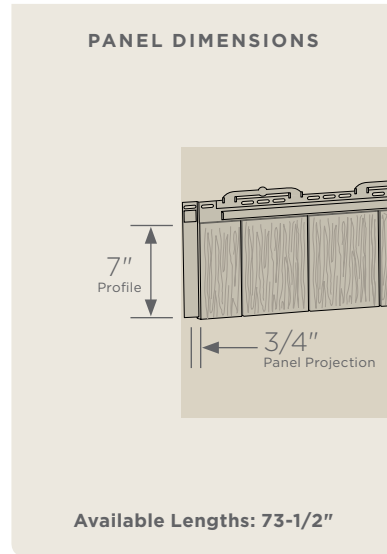
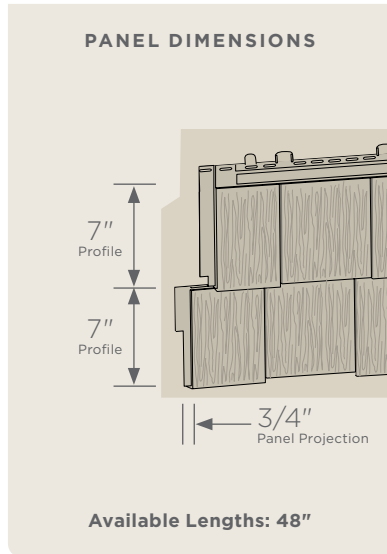
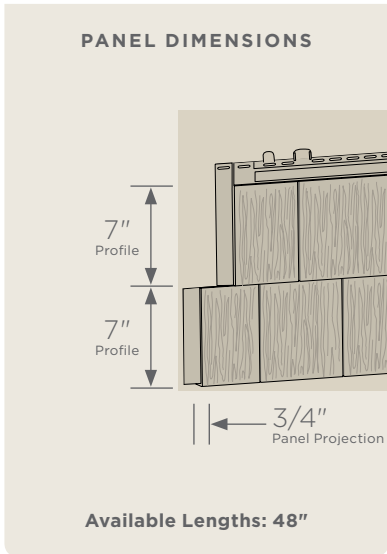

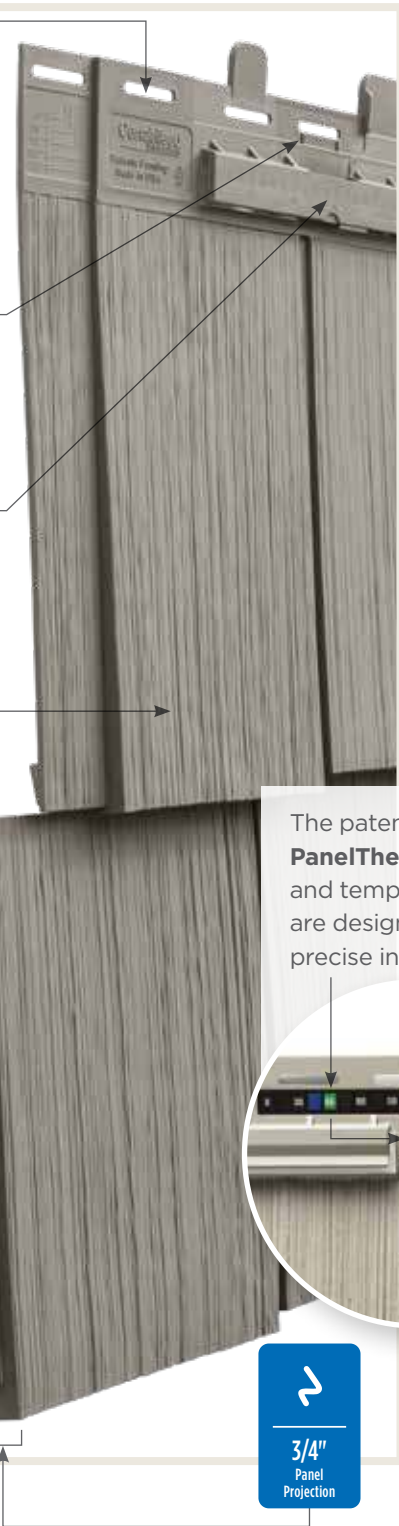

SureStop™
Recessed nailing area

HammerTapper™
Assist pads

EasyMeasure™
Tape Measure

The patented **PanelThermometer™** and temperature lines are designed to ensure precise installation.

3/4" Panel Projection

3/4" Panel Projection

CertiLock Continuous Hanger

Perfection



Cedar Impressions 7" Staggered Perfection Offset Mitered Cornerpost



Cedar Impressions 7" Straight Edge Perfection Offset Mitered Cornerpost

▲ Consistent variegated color throughout the panel.













** Premium Colors

	D7 Straight Edge Perfection Shingles	D7 Staggered Perfection Shingles	S7 Straight Edge Perfection Shingles
Natural Blend**			▲
Driftwood Blend**			▲
Cedar Blend**			▲
Rustic Blend**			▲
Brownstone	●		
Melrose	●		
Autumn Red	●	●	
Mountain Cedar		●	
Tuxedo	●		
Slate	●		
Espresso	●		
Sable Brown	●	●	●
Sparrow	●	●	
Hearthstone	●	●	●
Spruce	●	●	
Forest	●	●	
Midnight Blue	●		
Deep Mineral	●		
Pacific Blue	●	●	●
Wedgewood Blue	●		
Flagstone	●	●	●
Smoky Gray	●		
Charcoal Gray	●	●	●
Castle Stone	●		
Granite Gray	●	●	●
Graystone	●	●	
Sterling Gray	●	●	●
Bermuda Blue	●		
Seagrass	●	●	●
Cypress	●	●	●
Herringbone	●	●	
Desert Tan	●	●	
Weathered Wood	●		
Natural Clay	●	●	●
Savannah Wicker	●	●	●
Heritage Cream	●	●	
Snow	●		
Colonial White	●	●	●

Cedar Impressions®

Perfection Shapes



- 
3
- 
8
- 
up to
200mph
- 
Reinforced
Nail Slots
- 
3/4"
Panel
Projection
- 
Perfection
- 
Molded
Perimeter
Lock
- 
CertiLock
Continuous
Hanger
- 
Lifetime
Limited
Warranty
- 
Fastener
Indicators
- 
Low
Maintenance
- 
Drainability

Siding: Cedar Impressions Double 7" Straight Edge Perfection Shingles in Charcoal Gray and Cedar Impressions Single 6-1/3" Perfection Octagon Shapes in Charcoal Gray.
Trim: Vinyl Carpentry® & Restoration Millwork®.

	S6-1/3 Perfection Scallop	S6-1/3 Perfection Octagon	S6-1/3 Perfection Half Cove
Autumn Red	●	●	
Pacific Blue	●	●	●
Charcoal Gray	●	●	
Sterling Gray	●	●	●
Cypress	●		
Natural Clay	●	●	●
Savannah Wicker	●		
Colonial White	●	●	●

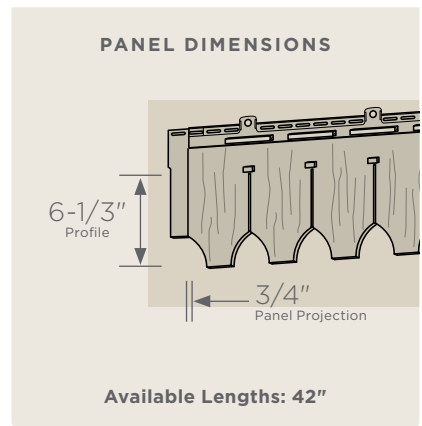
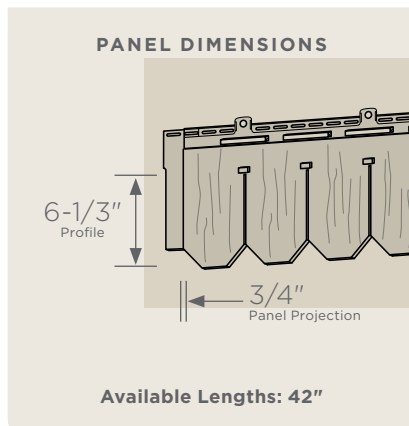
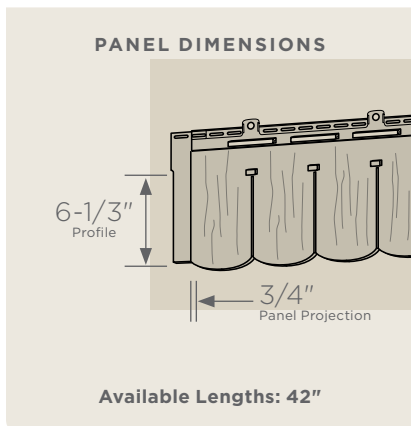
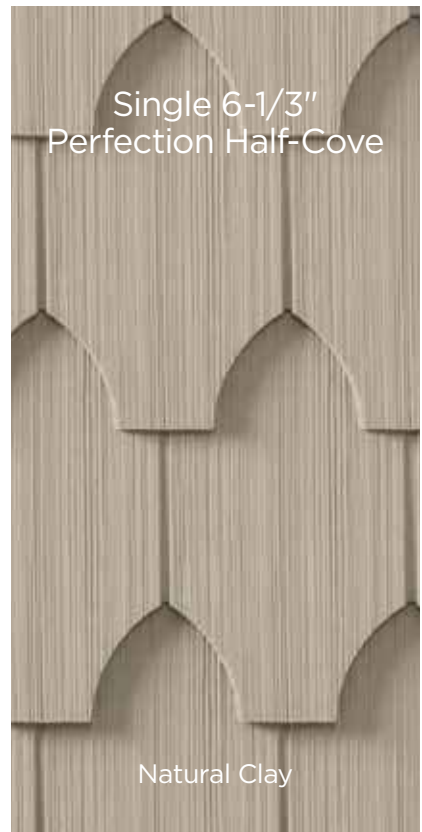

Cedar Impressions®

Rough-Split Shakes

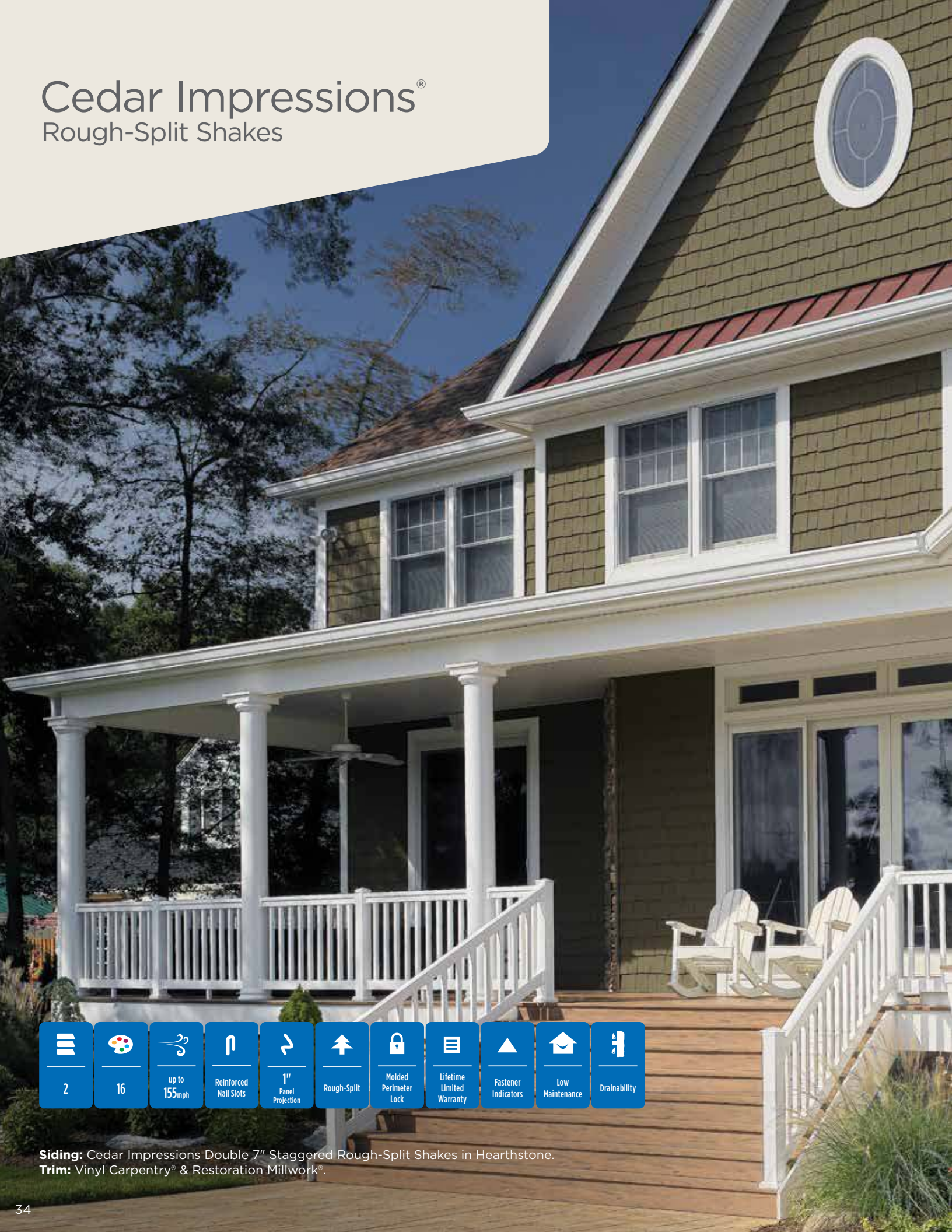

-  2
-  16
-  up to 155mph
-  Reinforced Nail Slots
-  1" Panel Projection
-  Rough-Split
-  Molded Perimeter Lock
-  Lifetime Limited Warranty
-  Fastener Indicators
-  Low Maintenance
-  Drainability

Siding: Cedar Impressions Double 7" Staggered Rough-Split Shakes in Hearthstone.
Trim: Vinyl Carpentry® & Restoration Millwork®.



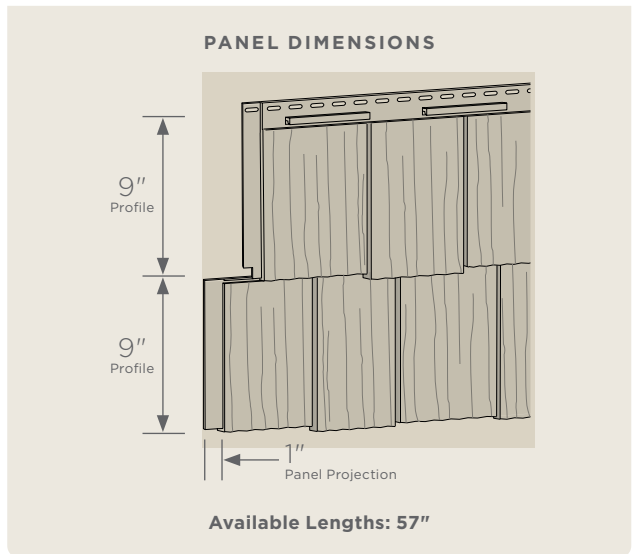
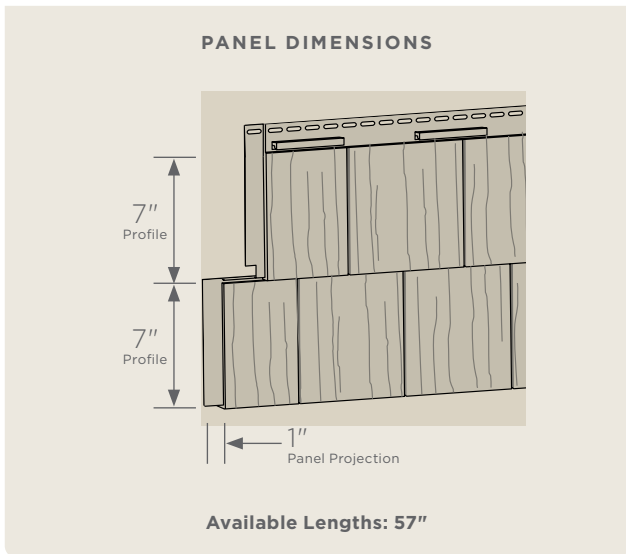
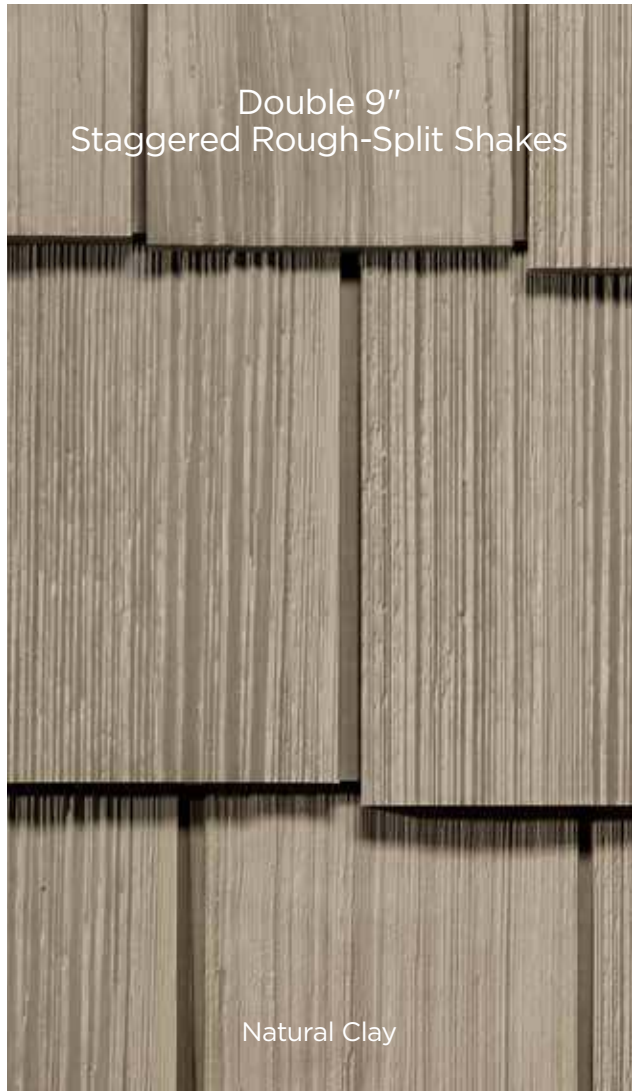

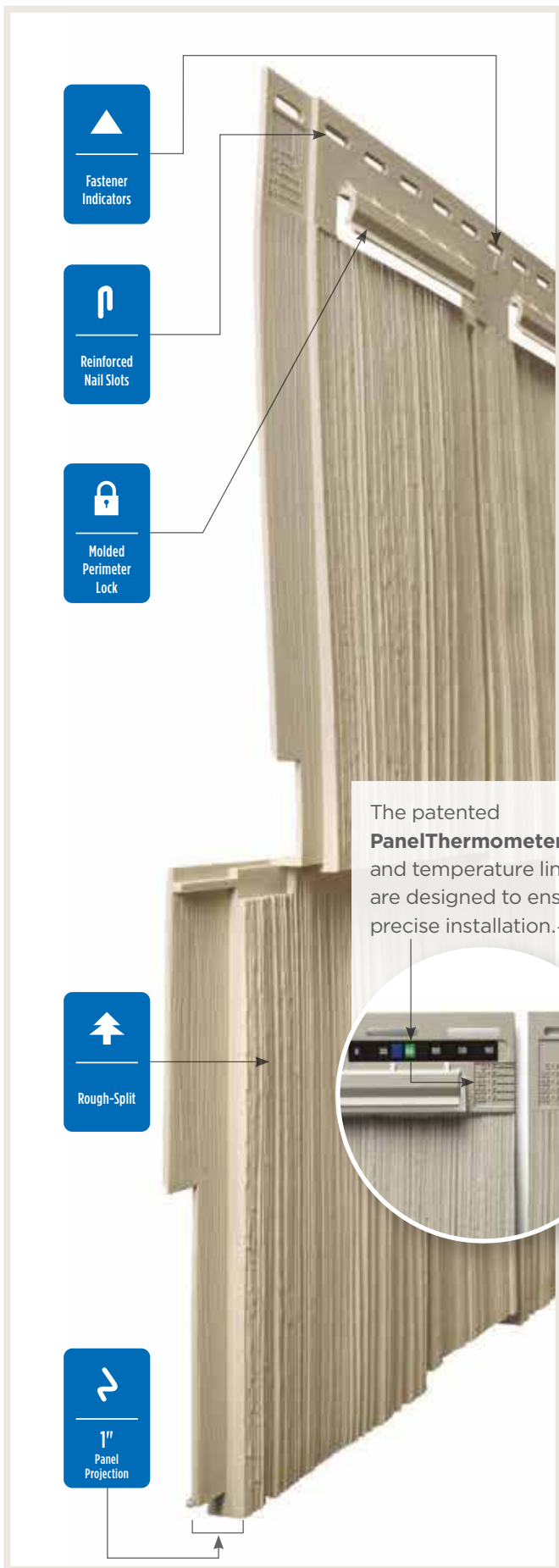

The patented **PanelThermometer™** and temperature lines are designed to ensure precise installation.

	D7 Straight-Edge Rough-Split Shakes	D9 Staggered Rough-Split Shakes
Autumn Red	●	●
Mountain Cedar	●	●
Sable Brown	●	●
Sparrow	●	
Hearthstone	●	●
Spruce	●	●
Forest	●	●
Pacific Blue	●	●
Flagstone	●	●
Charcoal Gray	●	●
Granite Gray	●	●
Sterling Gray	●	●
Natural Clay	●	●
Savannah Wicker	●	●
Buckskin	●	●
Colonial White	●	●

Mitered Outside Corner Posts



D7" Rough-Split

D9" Rough-Split

Northwoods®

Perfection Shingles, Rough-Split Shakes & Sawmill Shingles



3	20	up to 180mph	Standard Nail Hem	3/4" Panel Projection Perfection & Sawmill	1" Panel Projection Rough-Split	Perfection, Sawmill, Rough-Split	Lifetime Limited Warranty	Class A Flame Spread	Low Maintenance	Drainability

Siding: Northwoods Single 7" Straight Edge Rough-Split Shakes in Sterling Gray and Pacific Blue and Monogram Double 4" Clapboard in Sterling Gray.

Trim: Vinyl Carpentry®, Restoration Millwork® and Mounting Blocks.

Roof: Landmark® Series in Colonial Slate.



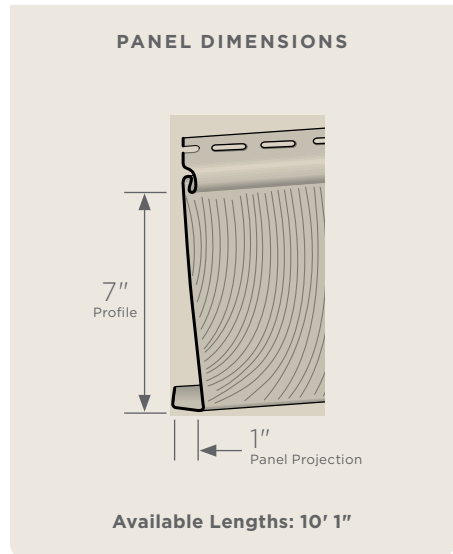
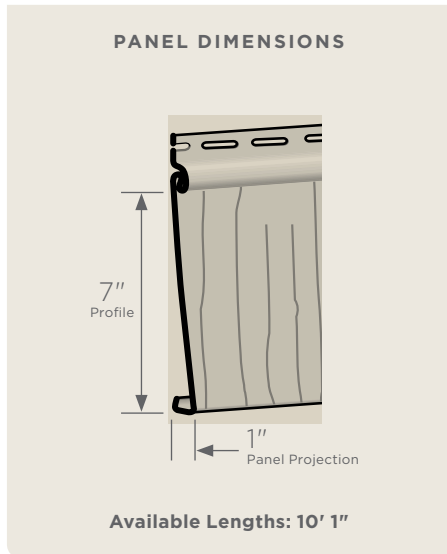
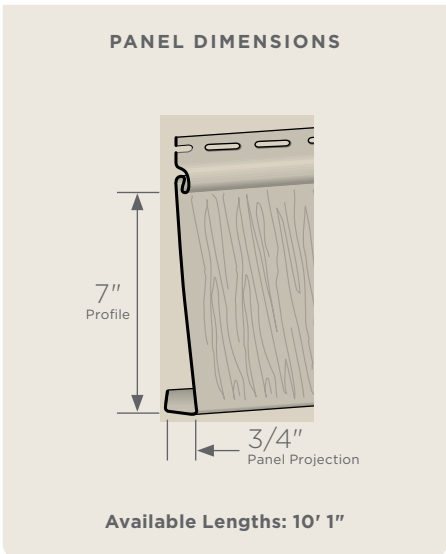

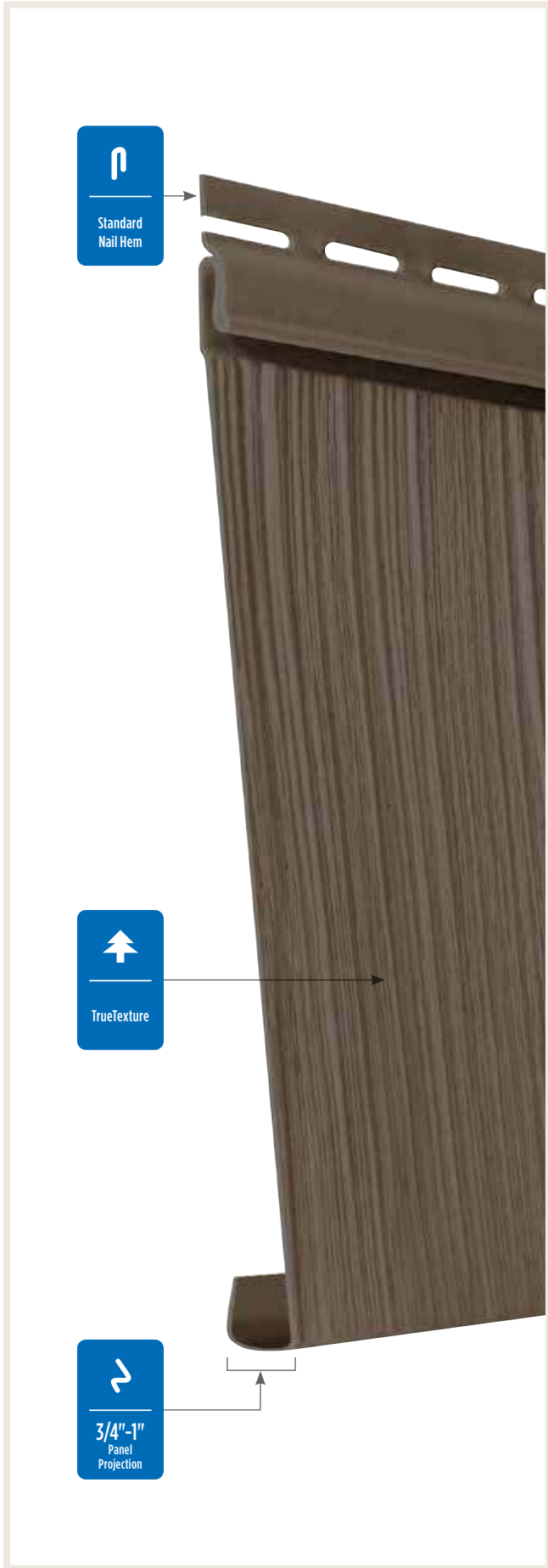

	S7 Straight Edge Perfection Shingles	S7 Straight Edge Rough-Split Shingles	S7 Straight Edge Sawmill Shingles
Autumn Red	●	●	
Slate	●		
Espresso	●		
Sable Brown	●	●	●
Midnight Blue	●		●
Pacific Blue	●	●	●
Flagstone	●	●	●
Smoky Gray	●		●
Charcoal Gray	●		●
Castle Stone	●		
Granite Gray	●	●	●
Sterling Gray	●	●	●
Seagrass	●		
Cypress	●	●	
Herringbone	●		
Sandstone Beige	●	●	
Desert Tan	●	●	
Natural Clay	●	●	●
Savannah Wicker	●	●	●
Colonial White	●	●	●



Siding: Northwoods Single 7" Straight Edge Rough-Split Shakes in Cypress with Monogram Double 4" Clapboard in Natural Clay.
Trim: Vinyl Carpentry® & Restoration Millwork®.

CedarBoards™

Insulated Siding

Chosen by Builders and Remodelers as the
#1 Insulated Siding
 in Brand Awareness, Performance and Use.

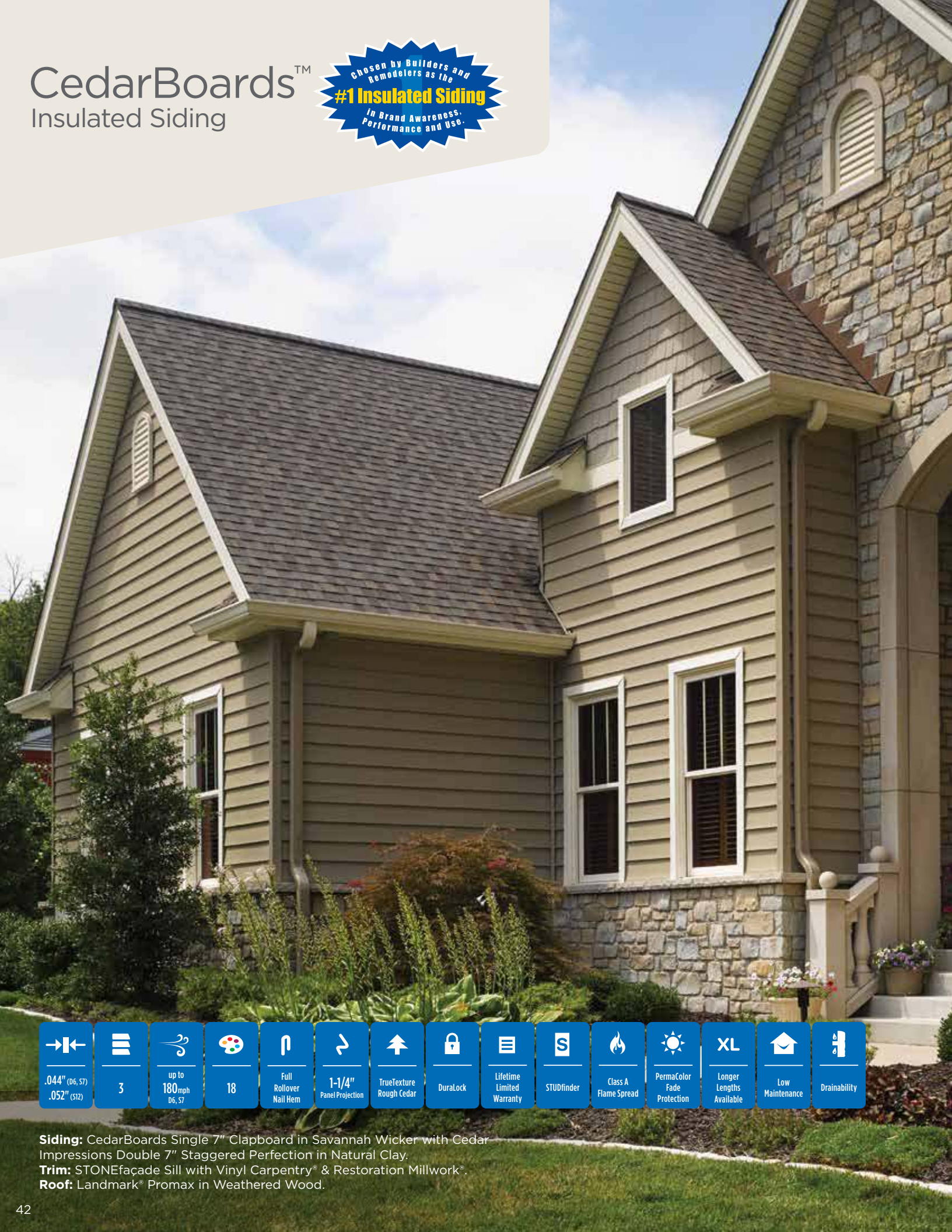

- ←
.044" (D6, S7)
.052" (S12)
- ≡
3
- ↻
up to
180mph
D6, S7
- 🎨
18
- ⤴
Full
Rollover
Nail Hem
- ↶
1-1/4"
Panel Projection
- 🌲
TrueTexture
Rough Cedar
- 🔒
DuraLock
- ☰
Lifetime
Limited
Warranty
- S
STUDfinder
- 🔥
Class A
Flame Spread
- ☀️
PermaColor
Fade
Protection
- XL
Longer
Lengths
Available
- 🏠
Low
Maintenance
- 🚰
Drainability

Siding: CedarBoards Single 7" Clapboard in Savannah Wicker with Cedar Impressions Double 7" Staggered Perfection in Natural Clay.
Trim: STONEfaçade Sill with Vinyl Carpentry® & Restoration Millwork®.
Roof: Landmark® Promax in Weathered Wood.





Double 6"
Rough Cedar Clapboard

Flagstone



Single 7"
Rough Cedar Clapboard

Savannah Wicker



Single 12"
Rough Cedar
Board & Batten

Autumn Red

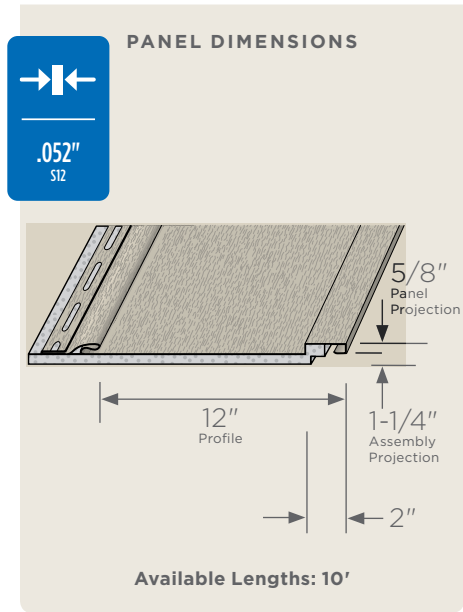
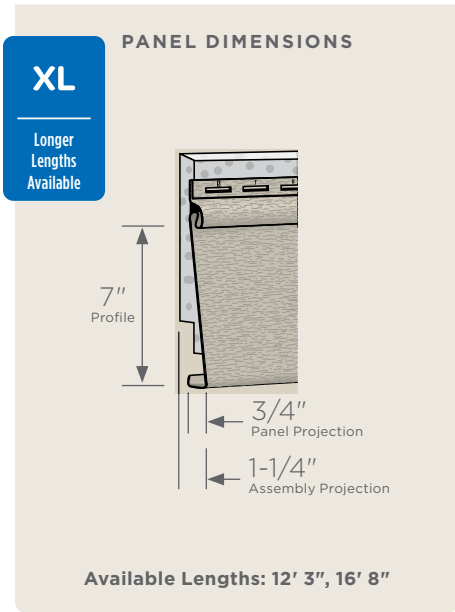
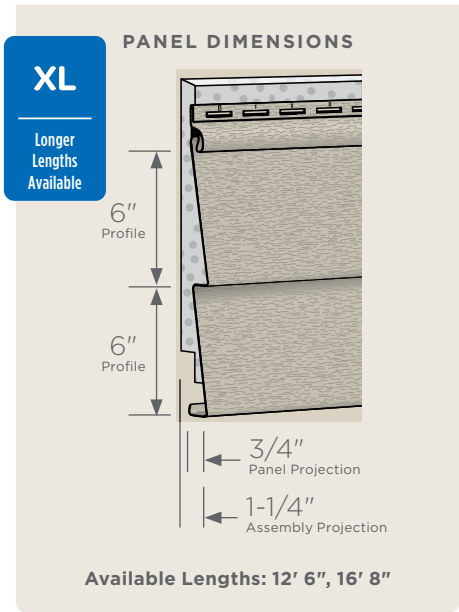

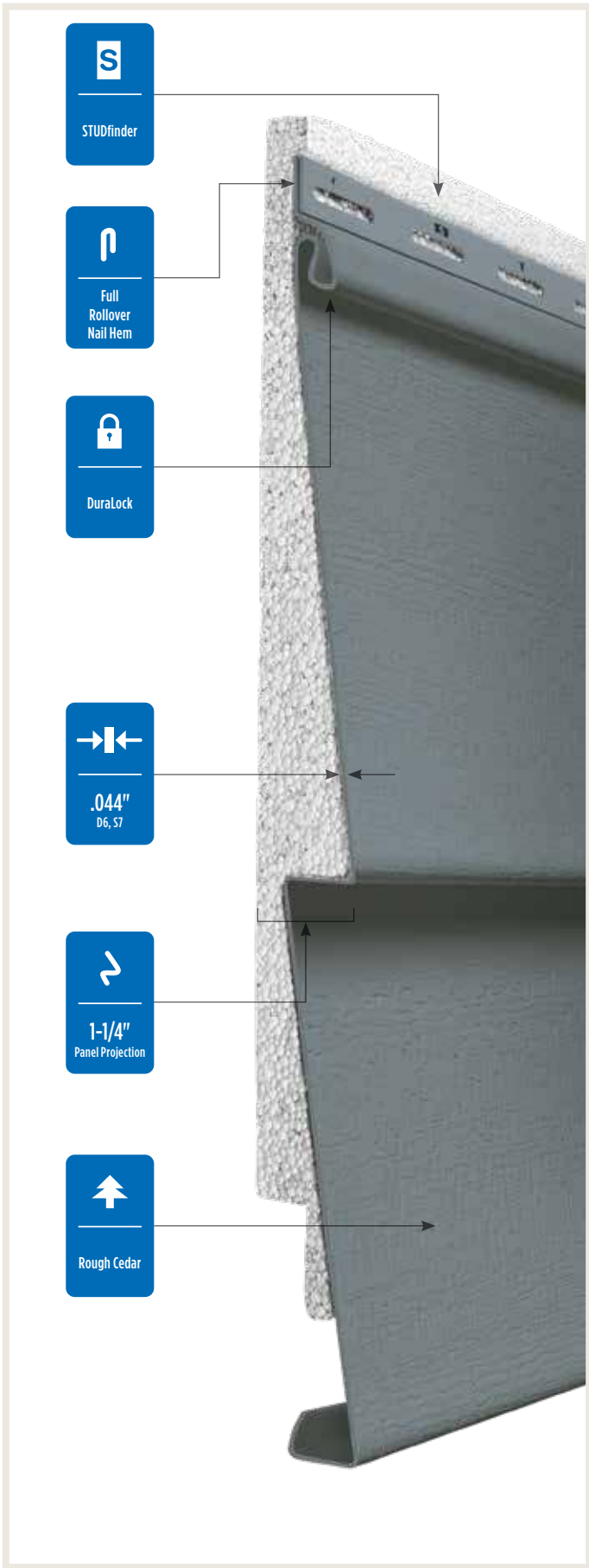

* Deluxe Colors

	D6 Clapboard	S7 Clapboard	S12 Board & Batten	XL D6 Clapboard	XL S7 Clapboard
Autumn Red*	●	●	●		
Sable Brown*	●	●			
Spruce*	●	●			
Pacific Blue*	●	●	●	●	
Flagstone*	●	●	●	●	●
Charcoal Gray*	●	●	●	●	●
Granite Gray	●	●	●	●	●
Sterling Gray	●	●	●	●	●
Oxford Blue	●	●			
Cypress	●	●		●	●
Herringbone	●	●	●		
Sandstone Beige	●	●			
Desert Tan	●	●			
Natural Clay	●	●	●	●	●
Savannah Wicker	●	●	●	●	●
Heritage Cream	●	●			
Snow			●		
Colonial White	●	●	●	●	●

Finishing Touches

A full line of Vinyl Carpentry accessories specially designed for use with CedarBoards Siding.



Board & Batten

Vertical Siding



.052" S7	.048" S8	3	30	up to 165 _{mph}	Standard Nail Hem	1/2" Panel Projection	TrueTexture Rough Cedar	Lifetime Limited Warranty	Class A Flame Spread	PermaColor Fade Protection	Low Maintenance	Drainability

Siding: Board & Batten Single 7" in Forest with Cedar Impressions Individual 5" Sawmill Shingles in Rustic Blend.
Trim: Vinyl Carpentry® & Restoration Millwork®.

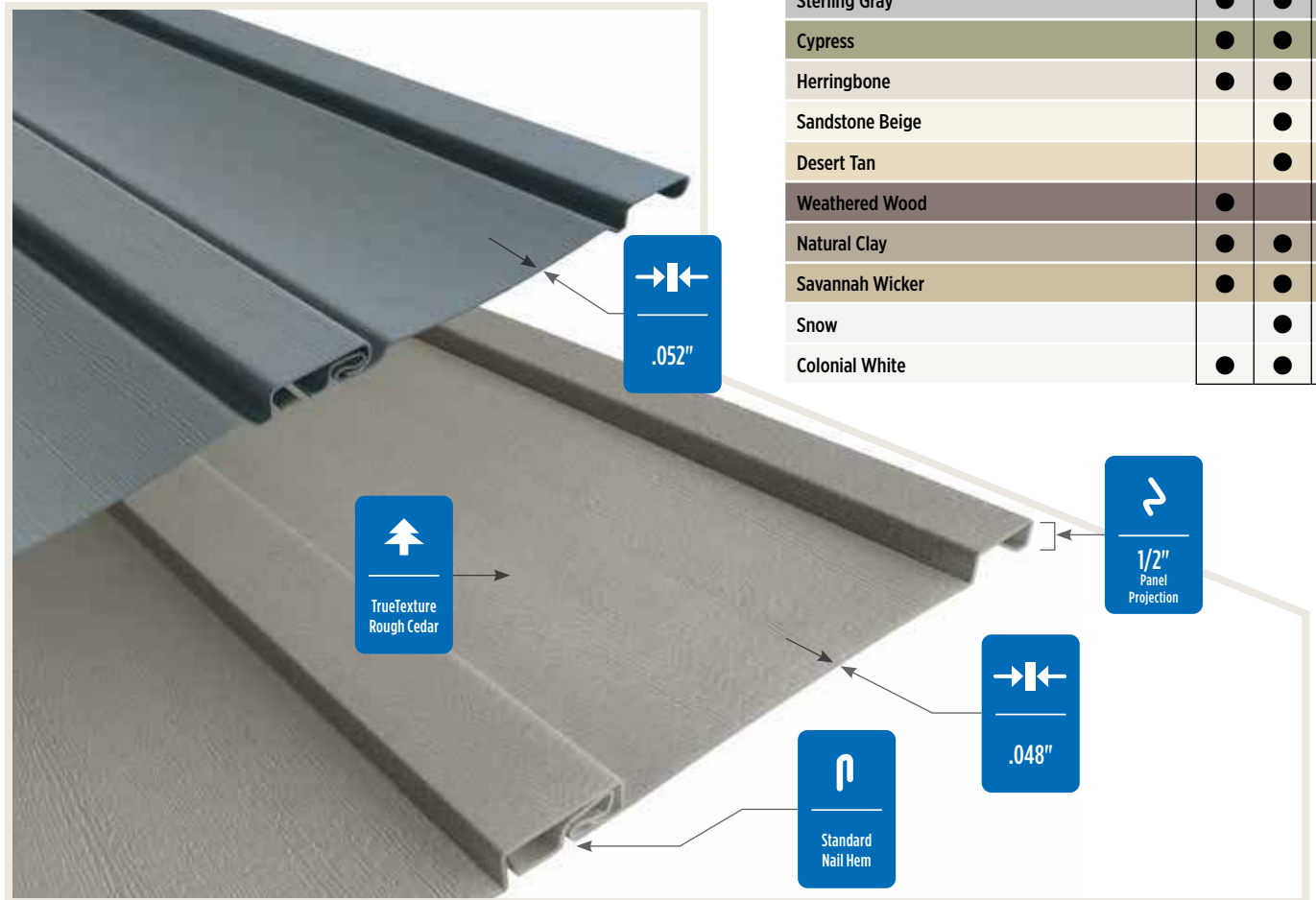
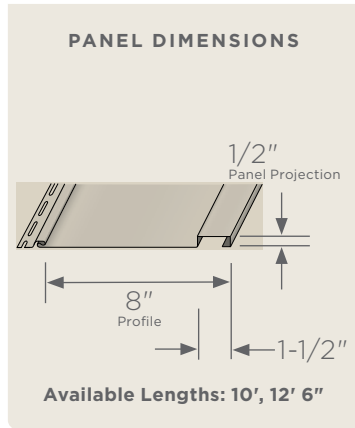
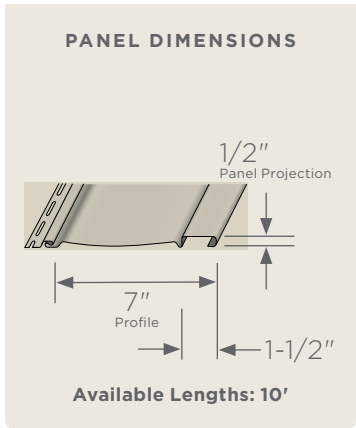
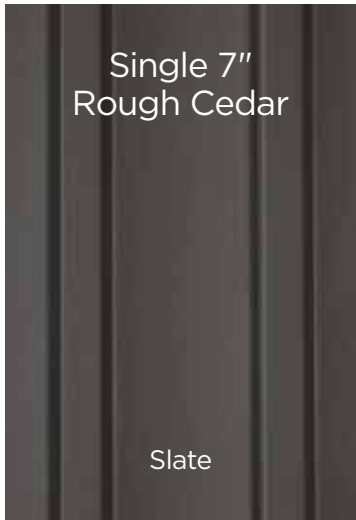

* Deluxe Colors

	S7 Board & Batten	S8 Board & Batten	S12 Board & Batten
Brownstone*	●		
Melrose*	●		
Autumn Red*	●	●	●
Tuxedo*	●		
Slate*	●		
Espresso*	●		
Sable Brown*	●		
Sparrow*	●		
Spruce*	●		
Forest*	●		
Midnight Blue*	●		
Deep Mineral*	●		
Pacific Blue*	●		●
Wedgewood Blue	●		
Flagstone*	●		●
Smoky Gray	●		
Charcoal Gray*	●		●
Castle Stone	●		
Granite Gray	●	●	●
Graystone	●	●	
Sterling Gray	●	●	●
Cypress	●	●	
Herringbone	●	●	●
Sandstone Beige		●	
Desert Tan		●	
Weathered Wood	●		
Natural Clay	●	●	●
Savannah Wicker	●	●	●
Snow		●	●
Colonial White	●	●	●

Monogram[®]



.046"	3	40	up to 210 _{mph}	Full Rollover Nail Hem	3/4" Panel Projection	TrueTexture Rough Cedar	CertiLock	Lifetime Limited Warranty	STUDfinder	Class A Flame Spread	PermaColor Fade Protection	Longer Lengths Available	Low Maintenance	Drainability

Siding: Monogram Double 4" Clapboard in Flagstone with Cedar Impressions Individual 5" Sawmill Shingles in Driftwood Blend and STONEfaçade in Adirondack Snowfall.

Trim: Vinyl Carpentry[®] and Mounting Blocks.

Columns: Tapered Round.





Double 4"
Rough Cedar Clapboard

Double 5"
Rough Cedar Clapboard

Double 5"
Rough Cedar Dutchlap

Brownstone

Wedgewood Blue

Driftwood Blend

XL
Longer Lengths Available

PANEL DIMENSIONS

4" Profile
4" Profile
3/4" Panel Projection

Available Lengths: 12' 6", 16' 8", 20', 25'

PANEL DIMENSIONS

5" Profile
5" Profile
3/4" Panel Projection

Available Lengths: 12'

XL
Longer Length Available

PANEL DIMENSIONS

5" Profile
5" Profile
3/4" Panel Projection

Available Lengths: 12', 16'

















**** Premium Colors**
*** Deluxe Colors**

All blends have matching variegated outside corner posts available.

	D4 Clapboard	D5 Clapboard	D5 Dutchlap	XL D4 Clapboard	XL D5 Dutchlap
Arbor Blend**	●		●		
Weathered Blend**	●		●		
Frontier Blend**	●		●		
Natural Blend**	●		●		
Driftwood Blend**	●		●		
Cedar Blend**	●		●		
Rustic Blend**	●		●		
Brownstone*	●	●	●	●	
Melrose*	●	●	●	●	
Autumn Red*	●	●	●	●	
Tuxedo*	●	●	●		
Slate*	●	●	●	●	
Espresso*	●	●	●	●	
Sable Brown*	●	●	●	●	
Sparrow*	●	●	●		
Spruce*	●	●	●		
Olive Grove*	●	●	●		
Forest*	●	●	●		
Midnight Blue*	●	●	●	●	
Deep Mineral*	●	●	●		
Pacific Blue*	●	●	●	●	
Wedgewood Blue	●	●	●		
Flagstone*	●	●	●		
Smoky Gray	●	●	●		
Charcoal Gray*	●	●	●	●	
Castle Stone	●	●	●	●	
Granite Gray	●	●	●	●	●
Graystone	●	●	●		
Sterling Gray	●	●	●	●	●
Oxford Blue	●	●	●	●	●
Seagrass	●	●	●		
Cypress	●	●	●	●	●
Herringbone	●	●	●		
Sandstone Beige	●	●	●		
Desert Tan	●	●	●		
Weathered Wood	●	●	●		
Natural Clay	●	●	●	●	●
Savannah Wicker	●	●	●	●	●
Heritage Cream	●	●	●	●	●
Colonial White	●	●	●	●	●

Restoration Classic™



-  .044"
-  5
-  29
-  up to 200_{mph}
-  Full Rollover Nail Hem
-  5/8" Panel Projection
-  Select Cedar Woodgrain & Smooth
-  DuraLock
-  Lifetime Limited Warranty
-  STUDfinder
-  Class A Flame Spread
-  PermaColor Fade Protection
-  Low Maintenance
-  Drainability

Siding: Restoration Classic Double 4" Clapboard in Midnight Blue with Northwoods Single 7" Straight Edge Perfection Shingles in Midnight Blue and Granite Gray and Board & Batten S7" in Granite Gray.
Trim: Vinyl Carpentry® & Restoration Millwork®.



Double 4"
Select Cedar Clapboard

Smoky Gray



PANEL DIMENSIONS

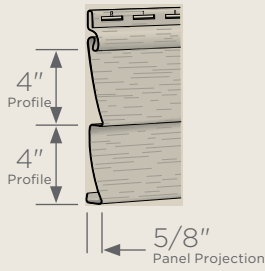

Available Lengths: 12' 6"

Double 4-1/2"
Select Cedar Dutchlap

Olive Grove



PANEL DIMENSIONS

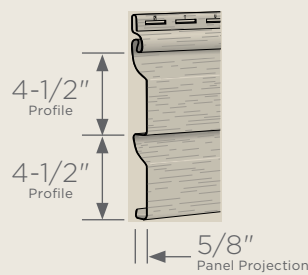

Available Lengths: 12' 1"

Double 5"
Select Cedar Clapboard

Heritage Cream



PANEL DIMENSIONS

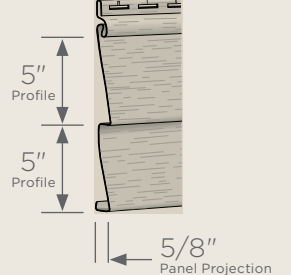

Available Lengths: 12'

Double 4-1/2"
Smooth Clapboard

Natural Clay



PANEL DIMENSIONS

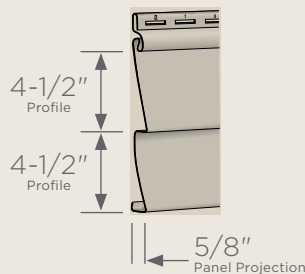

Available Lengths: 12' 1"

Triple 3"
Smooth Clapboard

Cypress



PANEL DIMENSIONS

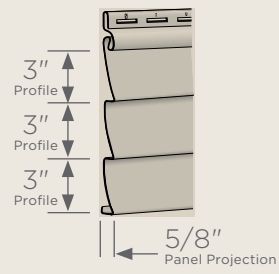

Available Lengths: 12' 1"

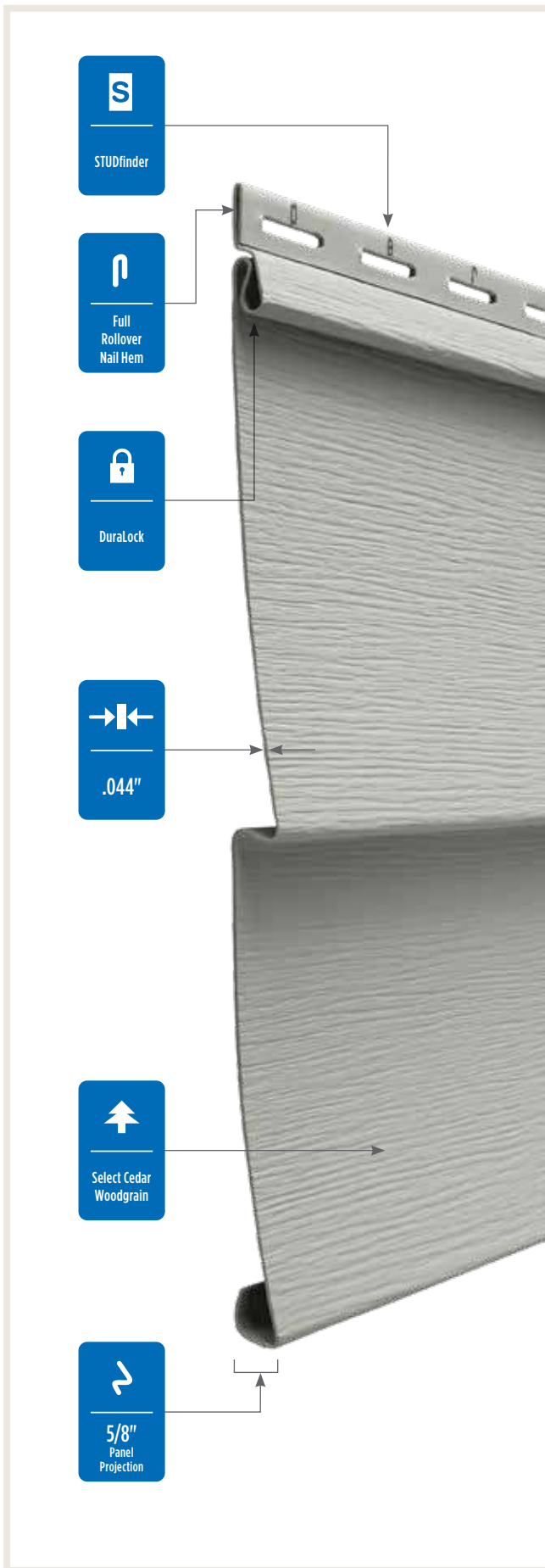

* Deluxe Colors















	D4 Clapboard	D4-1/2 Dutchlap	D5 Clapboard	D4-1/2 Clapboard	T3 Clapboard
Melrose*	●	●			
Autumn Red*	●	●			
Slate*	●	●			
Espresso*	●	●			
Sable Brown*	●	●			
Spruce*	●	●			
Olive Grove*	●	●			
Forest*	●	●			
Midnight Blue*	●	●			
Pacific Blue*	●	●			
Wedgewood Blue	●	●			
Flagstone*	●	●			
Smoky Gray	●	●			
Charcoal Gray*	●	●			
Castle Stone	●	●			
Granite Gray	●	●	●	●	●
Graystone	●	●			
Sterling Gray	●	●	●	●	●
Oxford Blue	●	●	●		
Seagrass	●	●	●		
Cypress	●	●	●	●	●
Herringbone	●	●	●	●	●
Desert Tan	●	●	●		
Weathered Wood	●	●			
Natural Clay	●	●	●	●	●
Savannah Wicker	●	●	●	●	●
Heritage Cream	●	●	●		
Autumn Yellow	●	●	●		
Colonial White	●	●	●	●	●



Siding: Restoration Classic Double 4" Clapboard in Espresso.
Trim: Vinyl Carpentry® & Restoration Millwork®.

Carolina Beaded™



-  .044"
-  1
-  14
-  up to 130_{mph}
-  Standard Nail Hem
-  3/4" Panel Projection
-  Brushed
-  Post-formed
-  Lifetime Limited Warranty
-  STUdfinder
-  Class A Flame Spread
-  PermaColor Fade Protection
-  Low Maintenance
-  Drainability

Siding: Carolina Beaded Single 6-1/2" in Heritage Cream.
Trim: Vinyl Carpentry® & Restoration Millwork®.

Single 6-1/2"
Brushed Beaded



Granite Gray

PANEL DIMENSIONS

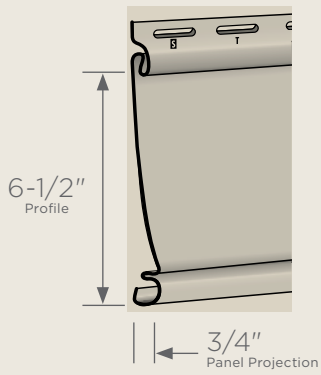





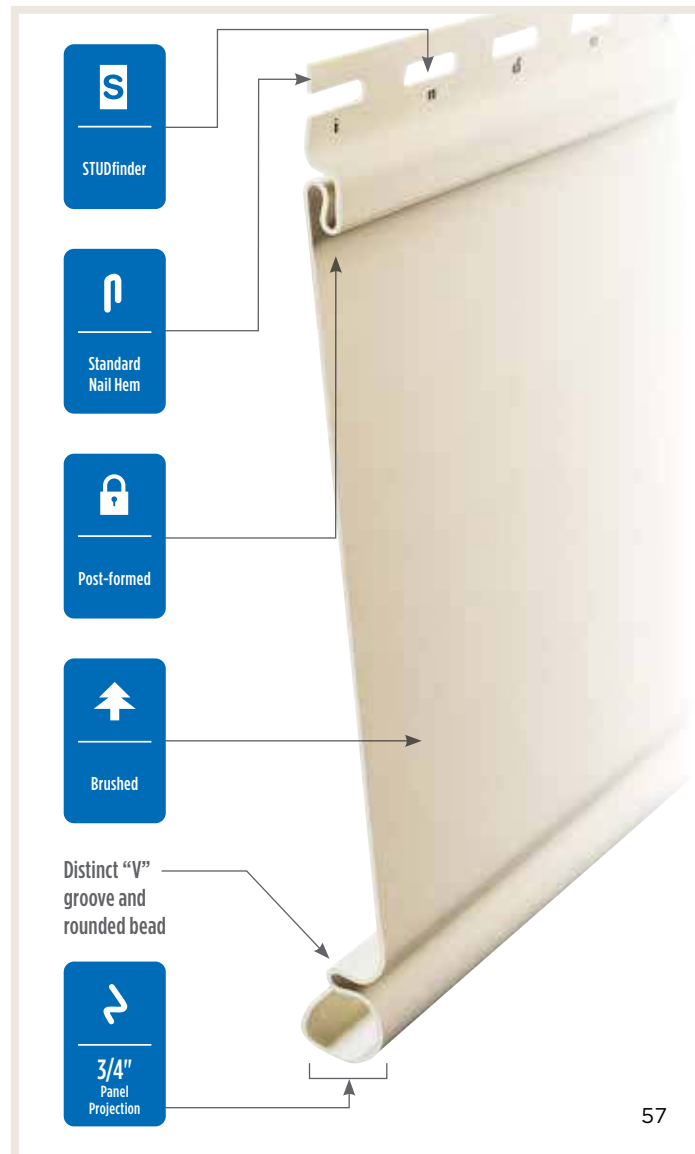



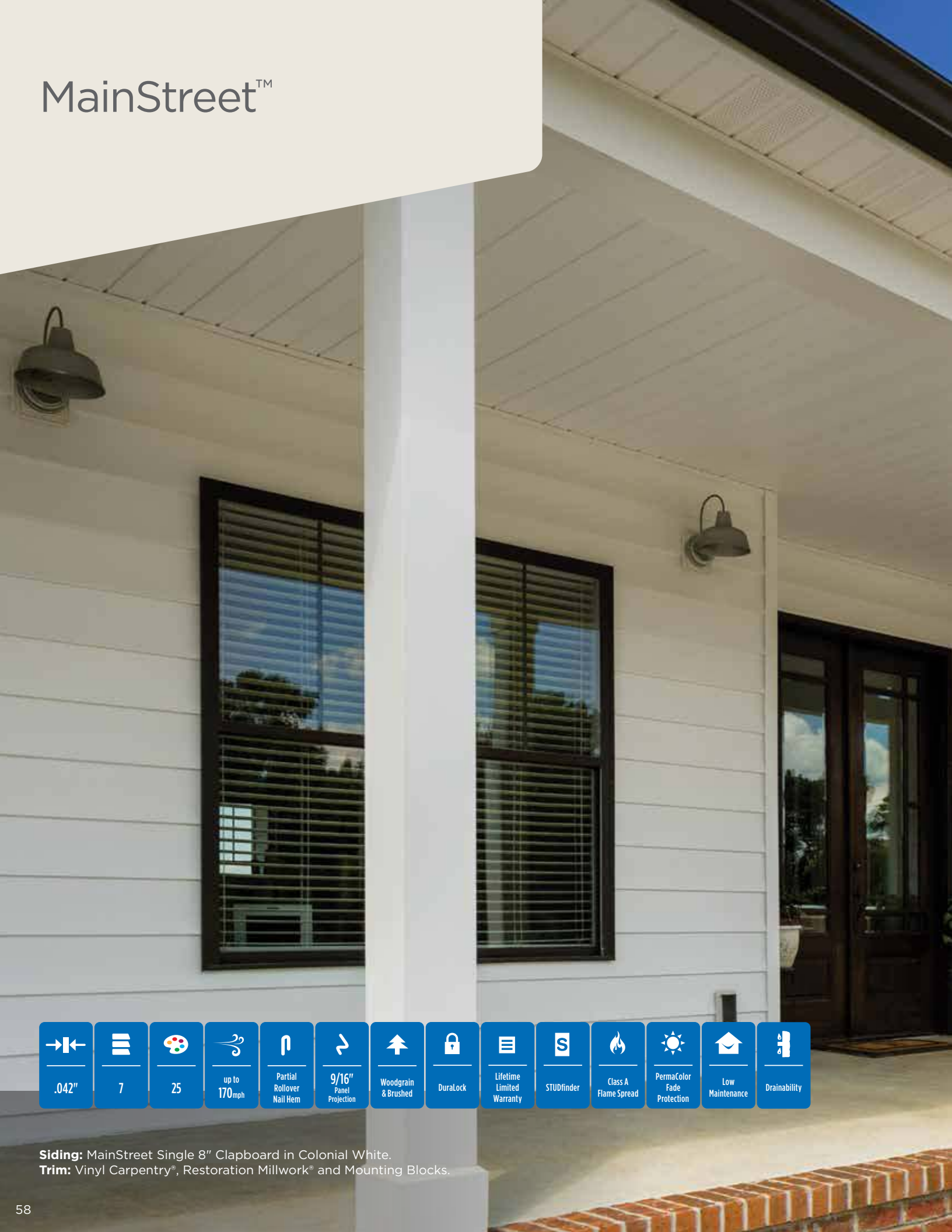





Available Lengths: 12' 4"

	56-1/2 Beaded
Castle Stone	●
Granite Gray	●
Sterling Gray	●
Oxford Blue	●
Seagrass	●
Cypress	●
Herringbone	●
Sandstone Beige	●
Desert Tan	●
Natural Clay	●
Savannah Wicker	●
Heritage Cream	●
Snow	●
Colonial White	●



MainStreet™



- 
.042"
- 
7
- 
25
- 
up to 170mph
- 
Partial Rollover Nail Hem
- 
9/16" Panel Projection
- 
Woodgrain & Brushed
- 
DuraLock
- 
Lifetime Limited Warranty
- 
STUDfinder
- 
Class A Flame Spread
- 
PermaColor Fade Protection
- 
Low Maintenance
- 
Drainability

Siding: MainStreet Single 8" Clapboard in Colonial White.
Trim: Vinyl Carpentry®, Restoration Millwork® and Mounting Blocks.





Double 4" Woodgrain Clapboard

Natural Clay



Double 5" Woodgrain Clapboard

Herringbone



Double 4" Woodgrain Dutchlap

Granite Gray



Double 5" Woodgrain Dutchlap

Forest



Triple Brush Clapboard

Desert

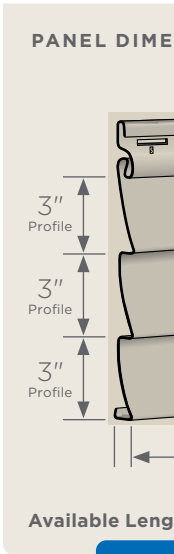
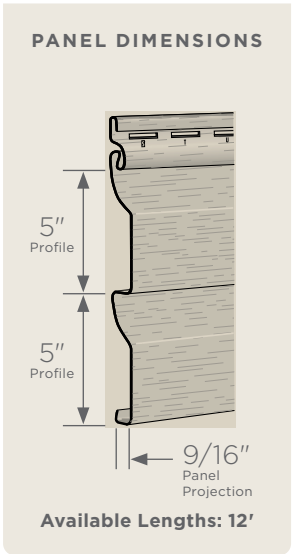
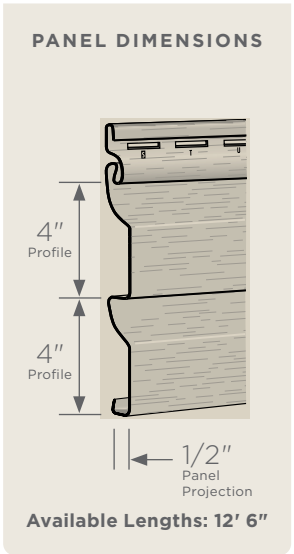
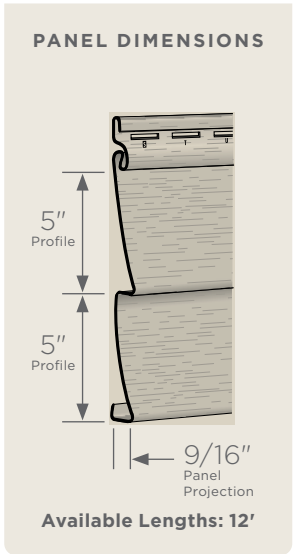
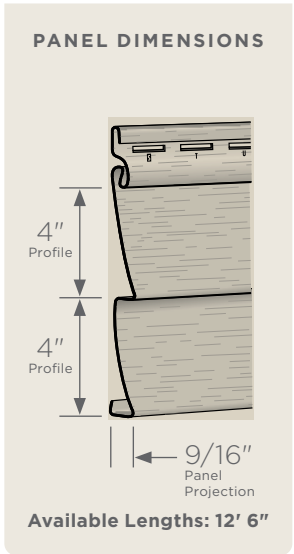



3"
ed
ard

Tan

NSIONS



9/16"
Panel
Projection

ths: 12' 1"



Single 6-1/2"
Brushed
Beaded

Cypress

PANEL DIMENSIONS

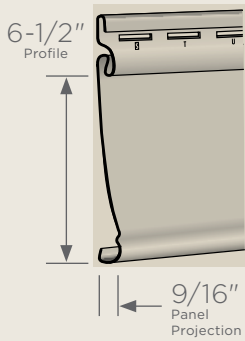

Available Lengths: 12' 4"



Single 8"
Woodgrain
Clapboard

Colonial White

PANEL DIMENSIONS

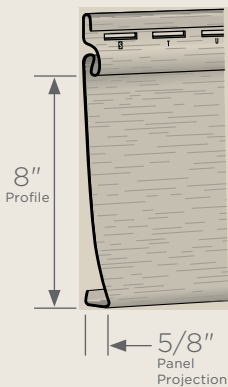















Available Lengths: 12' 6"

* Deluxe Colors

	D4 Clapboard	D5 Clapboard	D4 Duchlap	D5 Duchlap	T3 Clapboard	S6-1/2 Beaded	S8 Clapboard
Autumn Red*	●	●	●	●			
Sable Brown*	●	●	●	●			
Spruce*	●	●	●	●			
Forest*	●	●	●	●			
Pacific Blue*	●	●	●	●			
Wedgewood Blue	●	●	●	●			
Flagstone*	●	●	●	●			
Charcoal Gray*	●	●	●	●			
Castle Stone	●	●	●	●			
Granite Gray	●	●	●	●		●	
Graystone	●	●	●	●			
Sterling Gray	●	●	●	●	●	●	
Oxford Blue	●	●	●	●	●		
Seagrass	●	●	●	●			
Cypress	●	●	●	●		●	
Herringbone	●	●	●	●			
Sandstone Beige	●	●	●	●	●	●	
Desert Tan	●	●	●	●	●	●	
Weathered Wood	●	●	●	●			
Natural Clay	●	●	●	●	●	●	
Savannah Wicker	●	●	●	●	●	●	
Heritage Cream	●	●	●	●			
Autumn Yellow	●	●	●	●			
Snow	●	●	●	●	●		
Colonial White	●	●	●	●	●	●	●

American Legend™



-  .042"
-  3
-  18
-  up to 140_{mph}
-  Standard Nail Hem
-  9/16" Panel Projection
-  Woodgrain
-  GripLock
-  Lifetime Limited Warranty
-  STUdfinder
-  Class A Flame Spread
-  PermaColor Fade Protection
-  Low Maintenance
-  Drainability

Siding: American Legend Double 4" Clapboard in Charcoal Gray.
Trim: Vinyl Carpentry® Restoration Millwork® and Mounting Blocks.

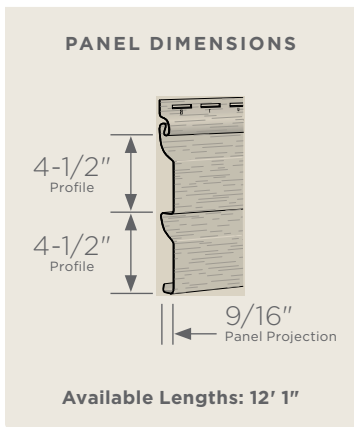
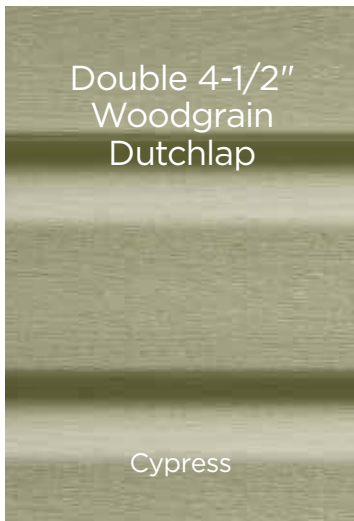
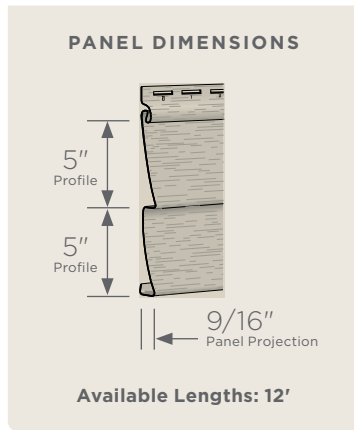
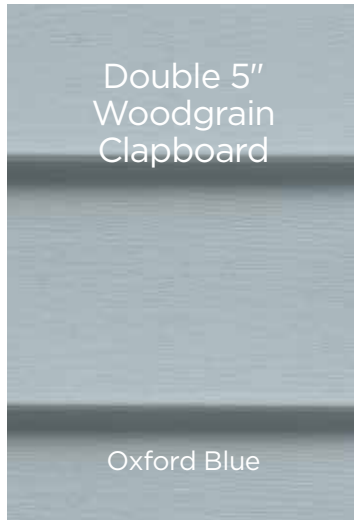
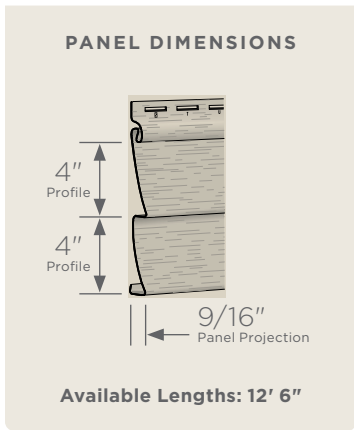
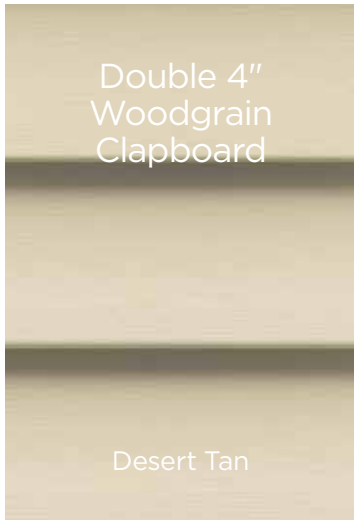

* Deluxe Colors

	D4 Clapboard	D5 Clapboard	D4-1/2 Dutchlap
Autumn Red*	●	●	●
Spruce*	●	●	●
Forest*	●	●	●
Flagstone*	●	●	●
Charcoal Gray*	●	●	●
Granite Gray	●	●	●
Sterling Gray	●	●	●
Oxford Blue	●	●	●
Seagrass	●	●	●
Cypress	●	●	●
Herringbone	●	●	●
Desert Tan	●	●	●
Natural Clay	●	●	●
Savannah Wicker	●	●	●
Heritage Cream	●	●	●
Autumn Yellow	●	●	●
Snow	●	●	●
Colonial White	●	●	●

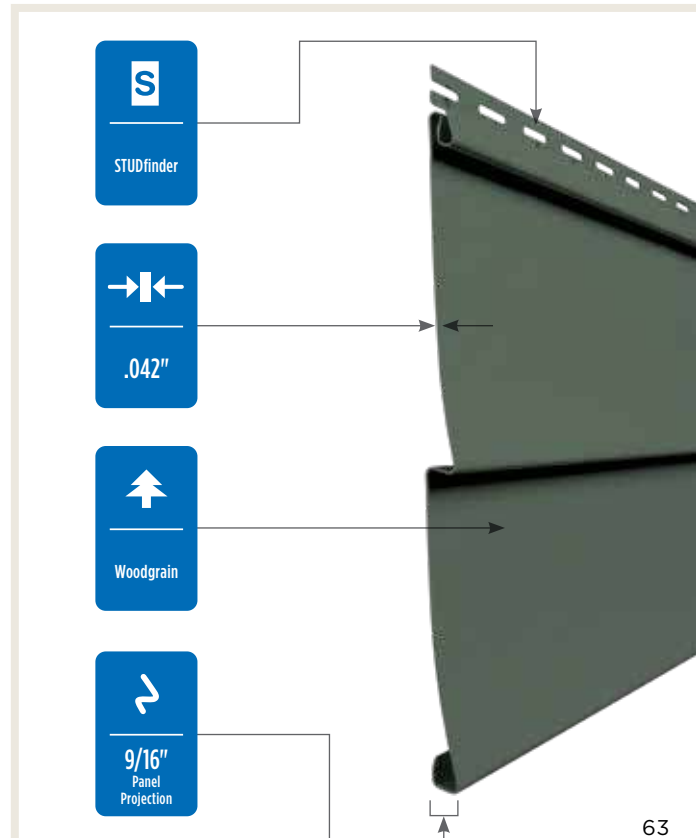

Encore™



- ←
.040"
- ≡
3
- 🎨
13
- 🌀
up to 170mph
- ⤴
Partial Rollover Nail Hem
- ↪
1/2" Panel Projection
- 🌲
Woodgrain
- 🔒
Post-formed
- ≡
Lifetime Limited Warranty
- S
STUDfinder
- 🔥
Class A Flame Spread
- ☀️
PermaColor Fade Protection
- 🏠
Low Maintenance
- 🚰
Drainability

Siding: Encore Double 4" Clapboard in Desert Tan.
Trim: Vinyl Carpentry®, Restoration Millwork® and Mounting Blocks.

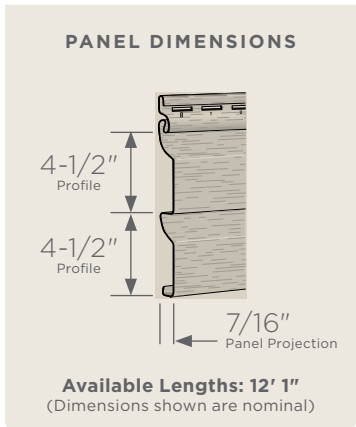
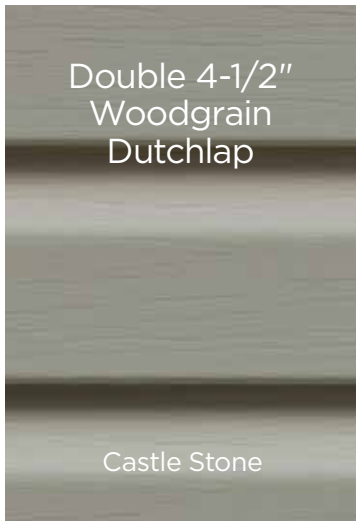
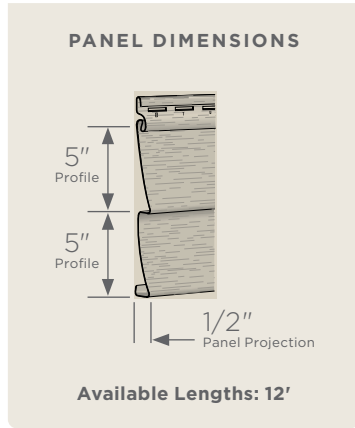
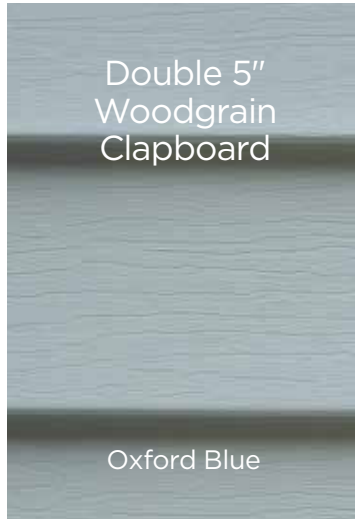
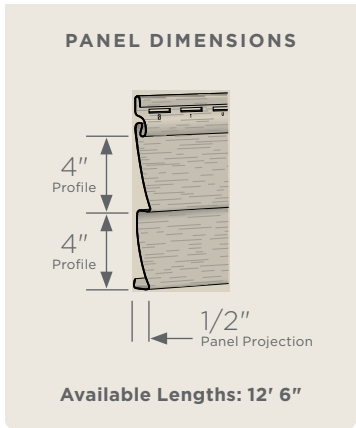
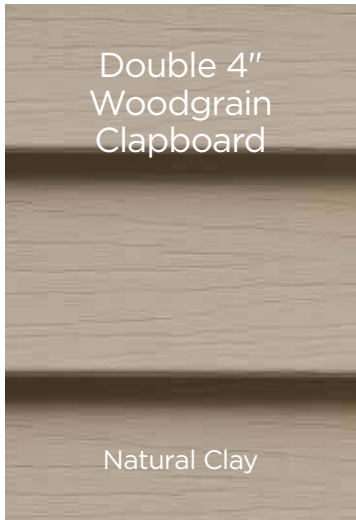

	D4 Clapboard	D5 Clapboard	D4-1/2 Dutchlap
Castle Stone	●	●	●
Sterling Gray	●	●	●
Oxford Blue	●	●	●
Seagrass	●	●	●
Cypress	●	●	●
Natural Clay	●	●	●
Herringbone	●	●	●
Sandstone Beige	●	●	●
Desert Tan	●	●	●
Savannah Wicker	●	●	●
Heritage Cream	●	●	●
Snow	●	●	●
Colonial White	●	●	●

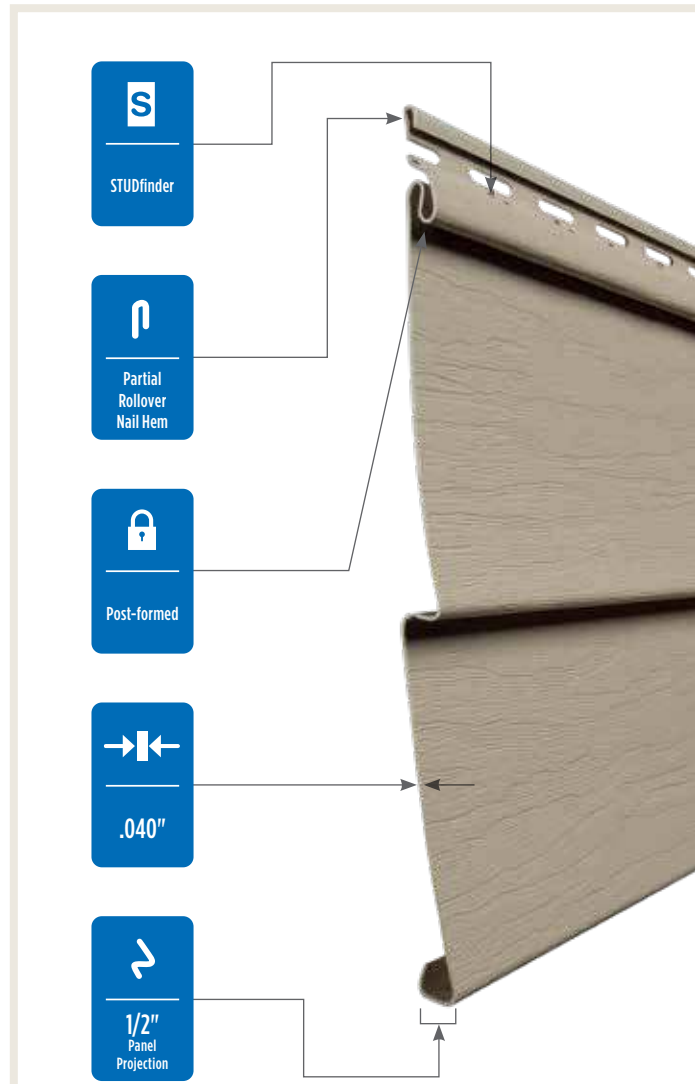

STONEfaçade®

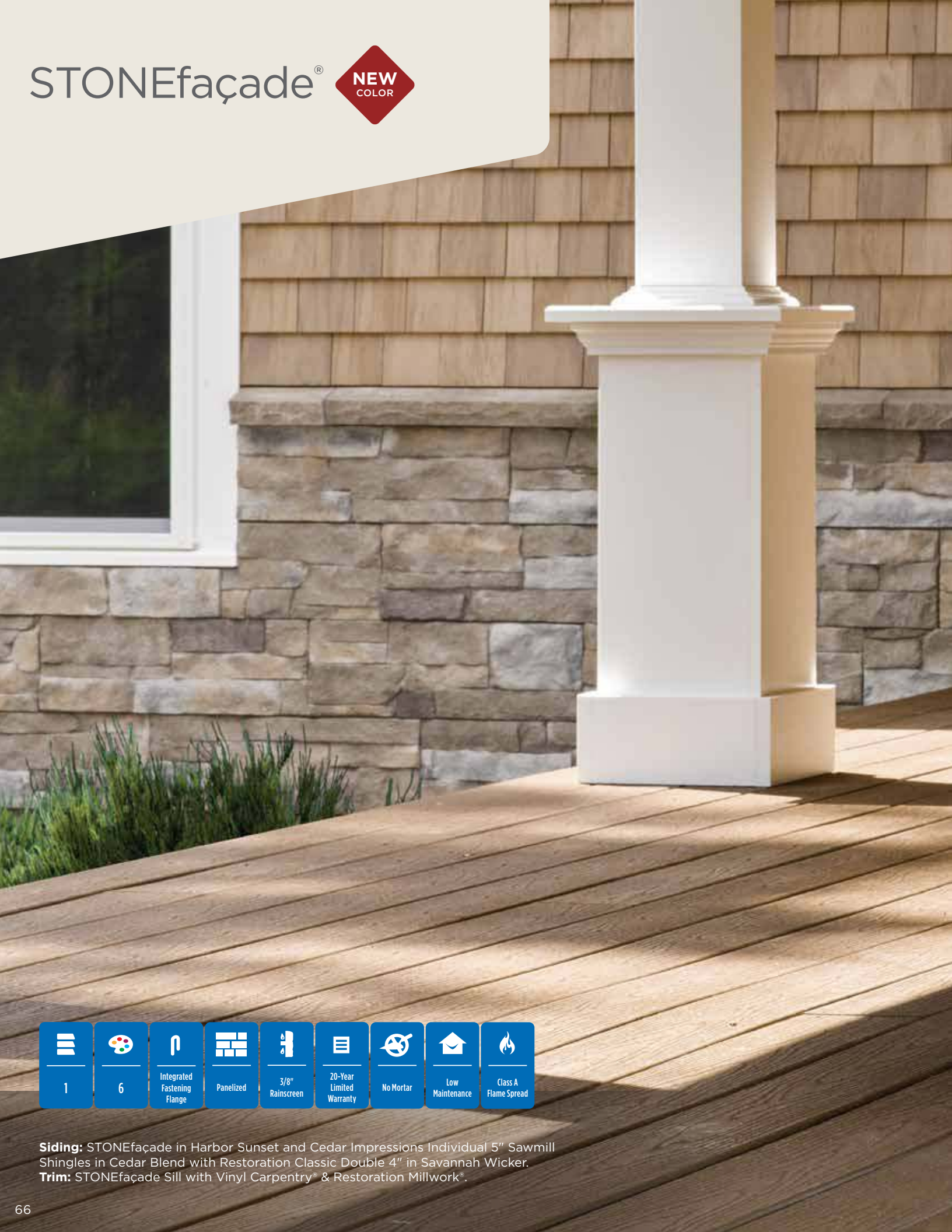

- 
1
- 
6
- 
Integrated Fastening Flange
- 
Panelized
- 
3/8" Rainscreen
- 
20-Year Limited Warranty
- 
No Mortar
- 
Low Maintenance
- 
Class A Flame Spread

Siding: STONEfaçade in Harbor Sunset and Cedar Impressions Individual 5" Sawmill Shingles in Cedar Blend with Restoration Classic Double 4" in Savannah Wicker.
Trim: STONEfaçade Sill with Vinyl Carpentry® & Restoration Millwork®.





Brown
Accessory color for
Sills, Light Boxes and
Electrical Boxes

Acadia Breeze



**NEW
COLOR**
Greige
Accessory color for
Sills, Light Boxes and
Electrical Boxes

Shenandoah Ridge



Dark Gray
Accessory color for
Sills, Light Boxes and
Electrical Boxes

Adirondack Snowfall



Charcoal
Accessory color for
Sills, Light Boxes and
Electrical Boxes

Coastal Storm

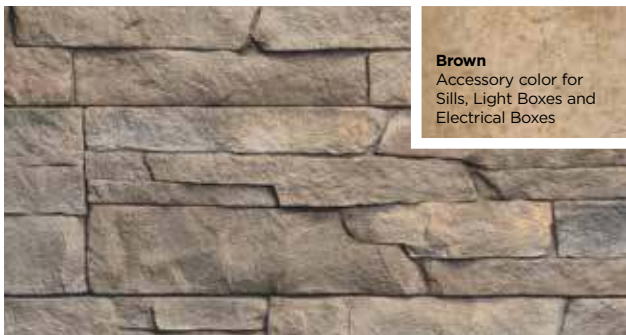

Brown
Accessory color for
Sills, Light Boxes and
Electrical Boxes

Pocono Autumn

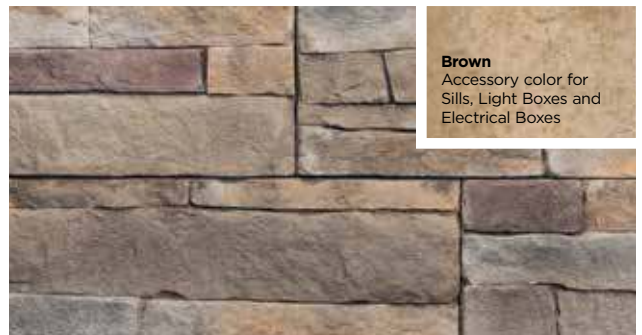

Brown
Accessory color for
Sills, Light Boxes and
Electrical Boxes

Harbor Sunset

PANEL DIMENSIONS

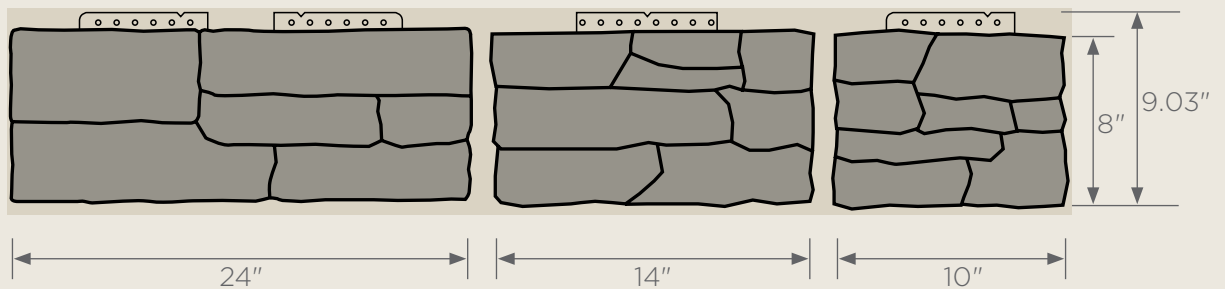

Product availability varies by region.

The patented fully-integrated rainscreen provides STONEfaçade additional structural support and superior drainage and will prevent moisture from accumulating in the wall cavity. The rainscreen insert also incorporates a fastening flange that allows STONEfaçade to be screwed to the substrate.



Oversized wrap around edge feature creates a more realistic and thicker finish compared to other stone veneer products that can have a thin appearance.



Easy-to-install stone veneer panels.

Finishing Touches

CertainTeed STONEfaçade includes a complete line of matching accessories.



Sills



Light Boxes



Electrical Boxes



Corners (Available in matching colors)

Soffit & Vertical Siding

Vinyl and Aluminum

Proper Ventilation is Critical

Protection against damage to the roofing materials and structure increase comfort inside the home and energy savings.

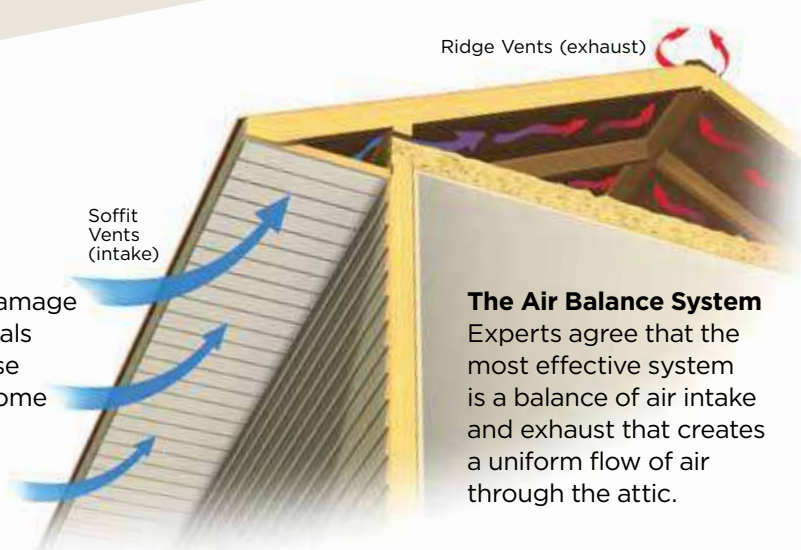

The Air Balance System
Experts agree that the most effective system is a balance of air intake and exhaust that creates a uniform flow of air through the attic.

This system creates a condition in which the roof temperature is equalized from top to bottom, supplying a uniform air flow along the entire underside of the roof deck.



Triple 3-1/3" InvisiVent

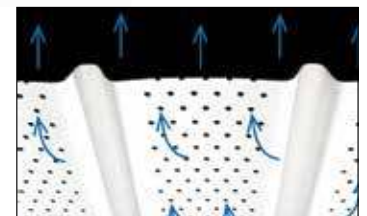

Standard vented soffit

Hidden vents provide a smooth, flat non-perforated surface versus most vented soffits with unsightly perforations.



Triple 3-1/3" InvisiVent offers at least 50% more ventilation than most standard vinyl soffit, providing more than 10" of net-free intake area. This means that not only will InvisiVent provide a balanced ventilation system, but will do so with an overhang as short as 10".



Triple 3-1/3" InvisiVent in Colonial White.

** Premium Colors

	T3-1/3 InvisiVent	T3-1/3 Perimeter	T2 Beaded
Black** <i>soffit use only</i>	●	●	
Charcoal Gray		●	
Granite Gray	●	●	
Sterling Gray			●
Bermuda Blue			●
Herringbone		●	
Sandstone Beige	●	●	●
Desert Tan	●	●	●
Natural Clay	●	●	●
Savannah Wicker	●	●	●
Snow	●	●	●
Colonial White	●	●	●

Invisivent[®] Triple 3-1/3"

Vinyl Soffit & Vertical Siding

- InvisiVent[®] hidden vent and solid styles.
- The only vinyl soffit to provide more than 10 inches of net-free intake area per square foot.
- Concealed intake vents provide a smooth appearance.
- Matte finish looks like freshly painted wood.
- Deep 3/4" panel projection creates sharp definition.
- 8 low-gloss colors.
- Heavy-duty .044" thickness for rigidity.

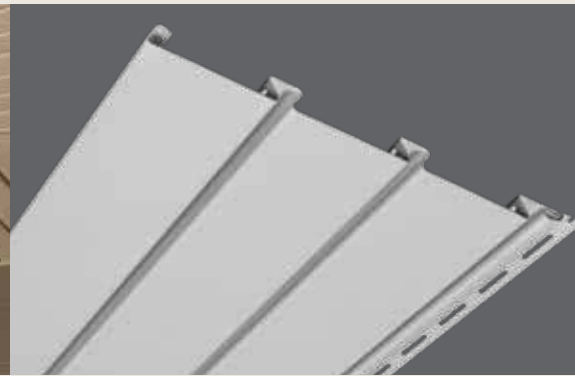

Perimeter[™] Triple 3-1/3"

Vinyl Soffit & Vertical Siding

- Hidden Vent and Solid Styles.
- 10 low-gloss colors.
- .040" thickness.
- Hidden vent style provides up to 9.65 inches of net-free intake area per square foot.

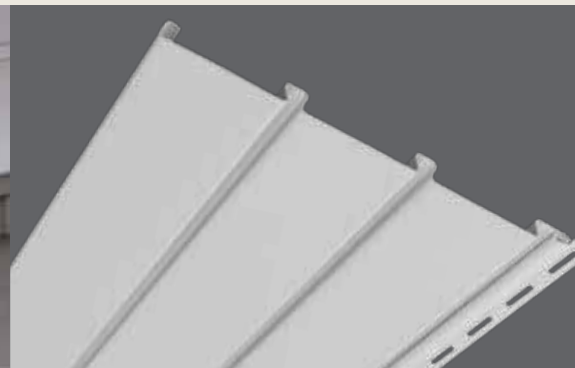

Beaded Triple 2"

Vinyl Soffit & Vertical Siding

- Wainscot style in solid and invisibly vented.
- Designed for vertical siding, porch ceiling and soffit applications.
- Smooth finish of professionally applied paint.
- Extra-long slip-lock design helps provide secure installation.
- 8 low-gloss colors.
- .039" thickness.
- 1.6 inches of net-free air per square feet - invisibly vented.

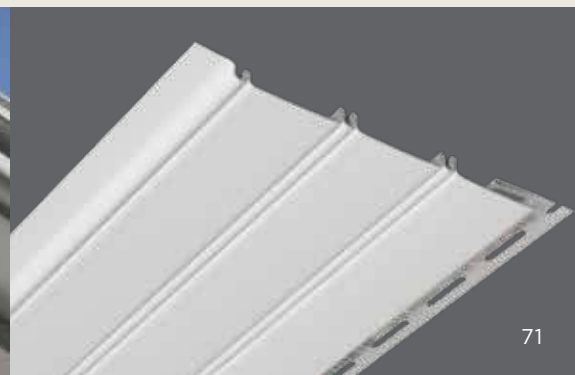

Ironmax™ Double 5"

Vinyl Soffit & Vertical Siding

- Solid and fully vented styles.
- Extra-thick .046" construction for optimum strength and flat face appearance.
- Designed for vertical siding, porch ceiling and soffit applications.
- Unique post-formed lock design helps ensure secure installation.
- 9 low-gloss woodgrain colors (Sable Brown for soffit applications only).
- 6.4 inches of net-free air per sq. ft.- fully vented.

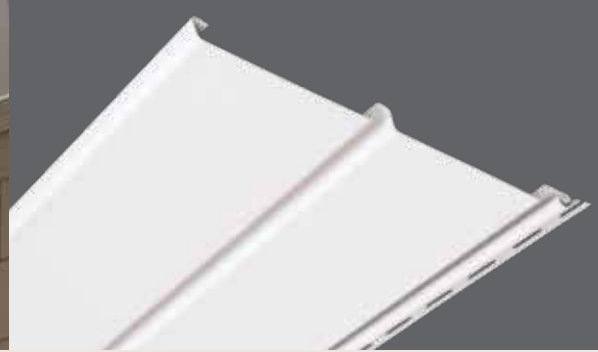

Universal Triple 4"

Vinyl Soffit & Vertical Siding

- Solid, fully vented and center vented styles. (Dimensions shown are nominal).
- Designed for vertical siding, porch ceiling and soffit applications.
- Matte finish.
- Post-formed lock design helps provide secure installation.
- 24 low-gloss colors (center vented: Colonial White and Snow only).
- .040" thickness.
- 5.9" of net-free air per sq.ft. - fully vented.
- 2 inches of net-free air per sq. ft. - center vented.

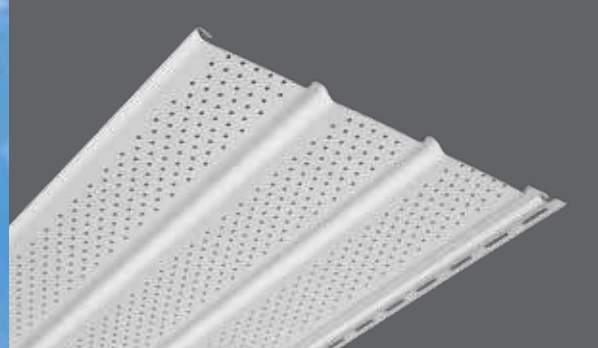

Universal Double 5"

Vinyl Soffit

- Solid and fully vented styles (soffit use only).
- Designed for soffit applications.
- Woodgrain finish.
- 8 low-gloss colors.
- .040" thickness.
- RigidForm technology provides strengthened nail hem for rigidity to perform under high wind conditions.
- 6.4 inches of net-free air per sq.ft. - fully vented.

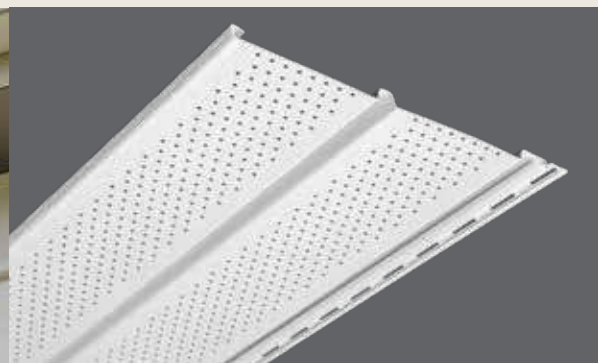



Ironmax Double 5" in Colonial White.

** Premium Colors

	D5 Ironmax	T4 Universal	D5 Universal	T4 Value	D5 Value
Black** <i>soffit use only</i>		●			
Musket Brown** <i>soffit use only</i>		●	●		
Brownstone		●			
Autumn Red		●			
Slate		●			
Espresso		●			
Sable Brown	●	●			
Forest		●			
Pacific Blue		●			
Flagstone		●			
Charcoal Gray		●			
Castle Stone		●			
Granite Gray	●	●			
Sterling Gray	●	●	●		
Oxford Blue		●			
Cypress		●			
Herringbone		●	●		
Sandstone Beige	●	●	●	●	
Desert Tan	●	●	●	●	
Natural Clay	●	●	●	●	
Savannah Wicker	●	●	●	●	
Heritage Cream		●			
Snow	●	●		●	
Colonial White	●	●	●	●	●

Value Triple 4" & Double 5" Vinyl Soffit

- Solid, fully vented and center vented styles.
- For use in new construction and remodeling.
- Post-formed lock design helps provide secure installation.
- Triple 4: 6 low-gloss colors (center vented: Colonial White only) (Dimensions shown are nominal).
- Double 5: 1 low-gloss color.



Triple 4"

Aluminum Soffit

- Solid, center vented and fully vented styles.
- Designed for soffit applications.
- 0.016" & 0.019" thickness options available.
- 4.4 inches of net-free air flow per sq.ft - fully vented.
- 1.47 inches of net-free air flow per sq.ft - center vented.

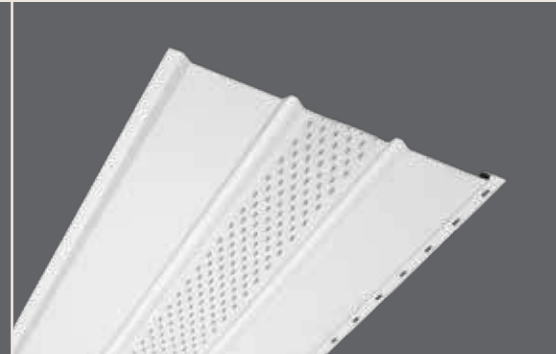
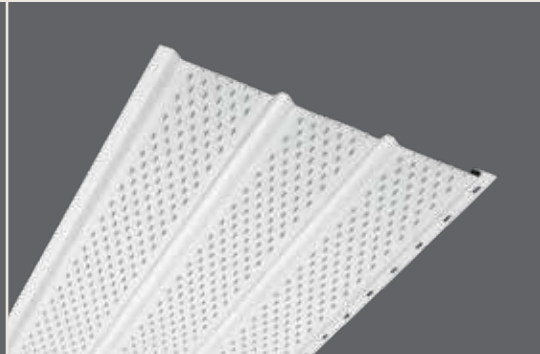

Quad 4"

Aluminum Soffit

- Solid, center vented and fully vented styles.
- Designed for soffit applications.
- 0.016" & 0.019" thickness options available.
- 11.5 inches of net-free air flow per sq.ft - fully vented.
- 5.75 inches of net-free air flow per sq.ft. center vented.

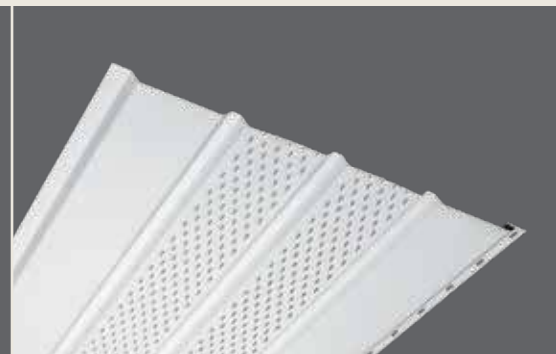
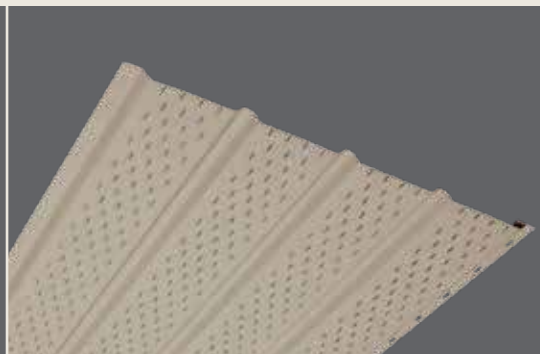

	T4	Q4
Black LG	●	●
Musket Brown	●	●
Natural Clay	●	●
Colonial White	●	●

Aluminum Accessories

New aluminum accessories include: Trim Coil, 3/8" J-Channel, 3/8" F-Channel, 6" Fascia, 8" Fascia, 1-1/2" Drip Edge and 2" Drip Edge.

Note: Trim Coil available in additional colors. Reference Product Catalog 04-08-30-US-EN for more information.

Black LG	●
Musket Brown	●
Natural Clay	●
Colonial White	●



Vinyl Carpentry®

Decorative Trim



T5" Straight Edge Sawmill
Offset Mitered Cornerpost



Cedar Impressions Double 9" Staggered
Rough-Split Shakes and Board & Batten
Single 8" Rough Cedar



J-Channel



Crown Molding with
3-1/2" Lineals

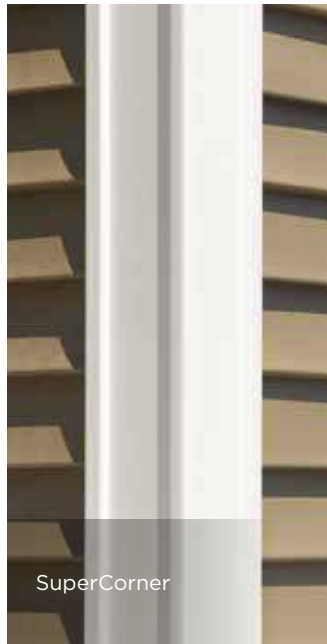

SuperCorner



Federal Corner created
with a 5" Lineal and a
3-1/2" Lineal

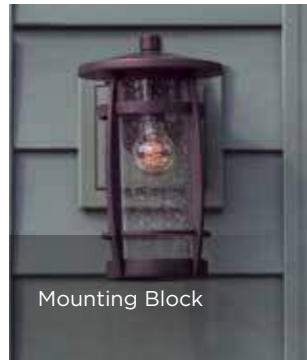

Mounting Block



Cedar Impressions Single
6-1/3" Perfection Octagon in
Autumn Red



Vinyl Carpentry®

Vinyl Carpentry trim offers you a wide array of decorative design possibilities to accent your home's exterior. Replicate the look of real wood with a wonderful assortment of styles and colors.

- Designed to add distinction to windows, doors, corners, gables and frieze boards.
- Authentic painted wood look.
- New construction and remodeling installation flexibility.
- Color - matching to coordinate with siding.
- Color-clear-through construction means scratches won't show.
- Color - matching Mounting blocks in a variety of styles and sizes
- Virtually maintenance free, never needs painting.

Create the look of true wood craftsmanship with a complete line of decorative accents and trim pieces for both new construction and remodeling.

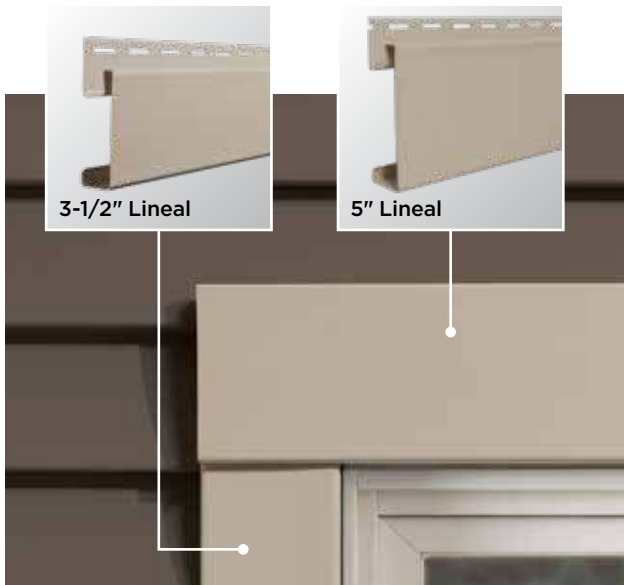

Window & Door Trim

- Crown Molding
- J-Channels
- Lineals



Corner Systems

- Outside Corner Posts
- Insulated Corner Posts
- Inside Corner Posts
- Mitered Corner Posts
- SuperCorners™
- Bay Window Corner Posts



Accents

- Cedar Impressions®
- Board & Batten
- Northwoods®



Wall & Soffit Transitions

- Cornice Molding
- Finish Board
- Band Board
- Double Channel Lineal
- H-Bars
- Lineals

Restoration Millwork[®]

Exterior Trim

The Ultimate Finish!

- Superior quality and excellent dimensional accuracy.
- Low-maintenance and long-lasting UV-resistant material.
- Natural white and ready to install.
- Can be painted* to complement exterior colors.
- Cuts and mills with traditional woodworking tools.
- Class A (Class 1) Flame Spread Classification.
- Made in U.S.A.
- Contains recycled content.
- 25-year limited warranty.

*See Installation Guidelines
17-03-1600-US-EN for painting instructions.

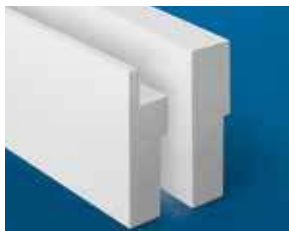

J-Pockets and Cut-Outs

Restoration Millwork trimboards with built-in J-pocket eases installation of corner trim and the cut-out allows the trimboard to lie flush with the siding around windows and doors with built-in nail flanges.



InvisiPro[®]

InvisiPro+ provides an attractive, easy-to-install alternative to traditional face nailing. One-Piece Corner & Trimboard Casing both feature a hidden nail hem integrated into the J-pocket to conceal fasteners. The end result is a nail-free face with no holes left to fill.



One-Piece Corner

One-piece corner components add style and beauty. Corners are available in natural white, and like all Restoration Millwork components, can be painted to match or coordinate with other exterior elements.

Skirtboard with DualStart[®] Design

Engineered with DualStart Design (patent-pending) cuts installation time while providing the 6 in. ground clearance required by U.S. building codes for fiber cement siding.



Sheets

Available in a full selection of custom and standard sizes and shapes, sheets can be used to create distinctive, one-of-a-kind exterior elements that are as beautiful as they are durable.

Specialty Profiles

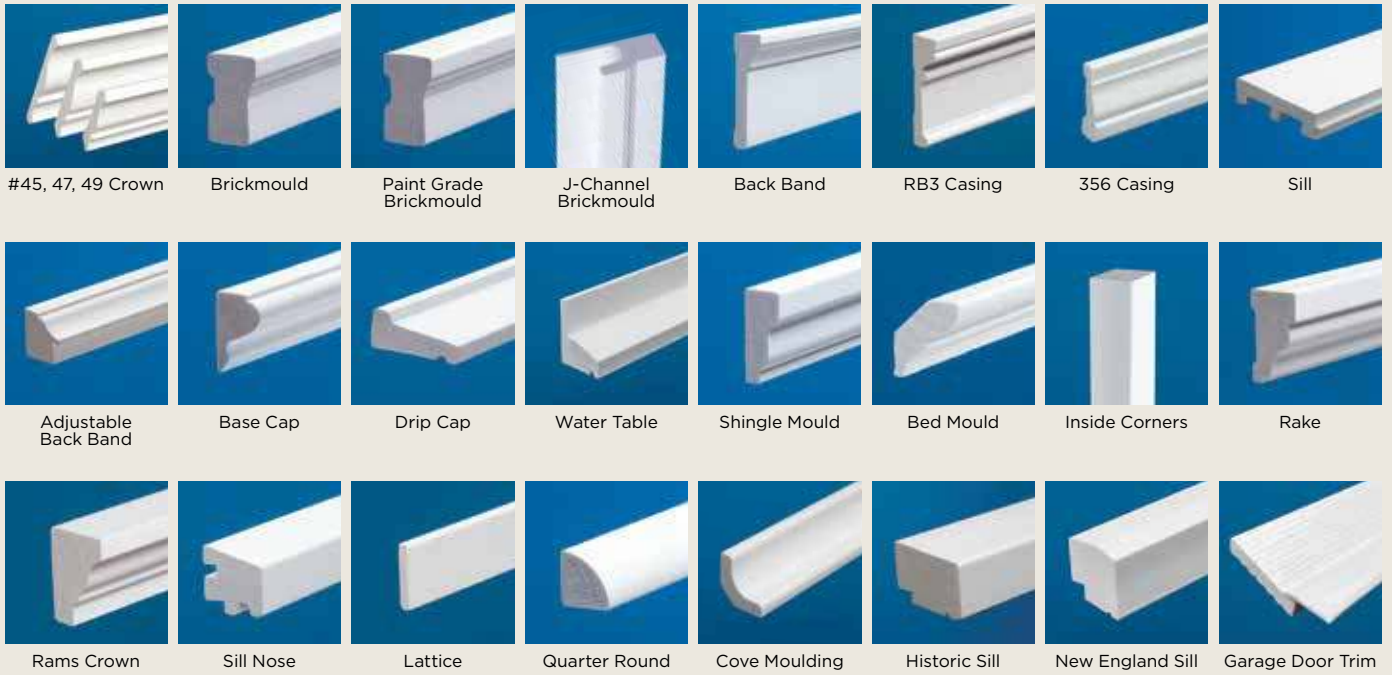

Column Wraps

Slides On, Swings Closed for Fast, Easy Installation

A three-sided wrap with a swinging door on the fourth side, Column Wraps are pre-cut and pre-mitered, to slide around existing wood load-bearing 4 in. x 4 in. or 6 in. x 6 in. porch posts.

Simple and versatile, with 2 column sizes: 8 in. x 8 in. and 10 in. x 10 in. square.



Beadboard with TightLap™

Whether you choose 2TL or 3TL, Beadboard with TightLap is designed to have a larger nailing area with the security of tongue and groove.

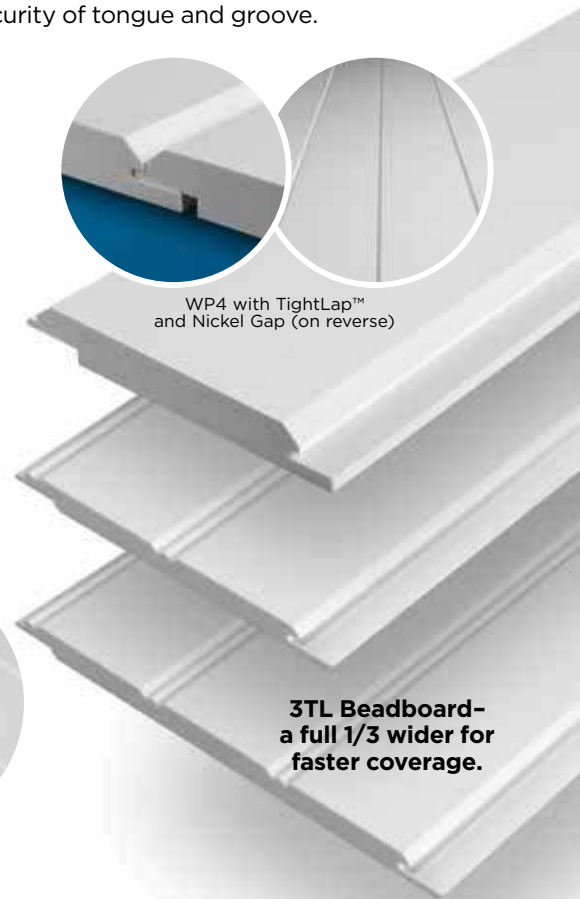

Fascia Trimboard

Fascia trimboard with built-in return leg is designed to work with a wide range of soffit materials. Available in TrueTexture™ and smooth finish.



Finishing Touches



J-Channel



3-1/3" Cornerpost



Restoration Millwork trimboard*



3-1/2" Lineal with miter cut corners



3-1/3" Cornerpost

Good

Better



Siding: CedarBoards™ Single 7" Clapboard in Sterling Gray.
Trim: Vinyl Carpentry® in Colonial White and Sterling Gray.
Roofing: Landmark® Shingles in Georgetown Gray.



Siding: CedarBoards Single 7" Clapboard and Board & Batten Single 8" in Sterling Gray with Cedar Impressions Double 7" Straight Edge Perfection Shingles in Charcoal Gray.
Trim: Vinyl Carpentry® & Restoration Millwork® in Colonial White.
Roofing: Landmark® Shingles in Georgetown Gray.

Details Create the Personality

Here are just a few of many ideas for finishing gables, windows, corners, columns, porches and more. With CertainTeed exterior products, there are no limits to the unique personality you can create. And by adding just the right balance of details, you are improving the curb appeal and value of your home.

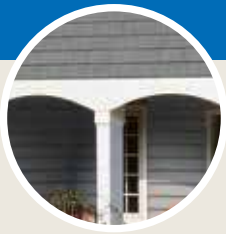

Restoration Millwork Classic Column Wraps



STONEfaçade® Corners



Vinyl Carpentry Cornice Molding and Restoration Millwork Rake Profile



Restoration Millwork Trimboard with Rams Crown



Restoration Millwork One-Piece Corner

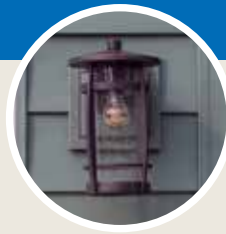

Mounting Blocks

Best



Siding: CedarBoards Single 7" Clapboard in Sterling Gray and Cedar Impressions Double 7" Straight Edge Perfection Shingles in Charcoal Gray with STONEfaçade in Adirondack Snowfall.

Trim: Vinyl Carpentry® & Restoration Millwork® in Colonial White.

Roofing: Landmark® Shingles in Georgetown Gray.

Weatherproofing



CERTAshield™ SA

CERTAshield™, previously Vycor enV-S®, self-adhered weather sheet-applied, self-adhered weather resistive barrier provides exceptional protection against water damage and air infiltration. It helps preserve the home's structural integrity and contributes to improved energy efficiency.

- Forms continuous barrier against water and air leakage, sealing all the critical entry points
- Installation does not require mechanical fasteners or taping of seams
- Strong adhesion to substrate allows the sheet to withstand weather conditions during the construction period
- Professional, high quality appearance on the house during the exposure period

Vycor® Butyl

Vycor® Butyl, previously Vycor® PRO, window and door flashing tape, with its highly conformable film and butyl-modified adhesive technology, provides premium protection against water infiltration in all critical non-roof detail areas. Vycor® Butyl contains no asphalt and is compatible with flexible PVC window flanges and leading sealant technologies.



Vycor® RA25

Vycor® RA25, previously Vycor® PLUS, is a high-performance self-adhered flashing that provides premium protection against water infiltration in critical details such as windows and doors. When properly installed, Vycor® RA25 flashing reduces the risk of mold and rot development, and contributes energy efficiency.



CertaWrap™ Premium Weather Resistant Barrier Performance

Superior Breathability, Water Resistance and Vapor Transmission

Mold, mildew and water damage are a home's worst enemies. An effective weather barrier system defends against these problems by resisting moisture penetration and air infiltration while allowing water vapor to dissipate. CertainTeed CertaWrap offers the industry's best combination of all of these properties, helping you defend against moisture and the elements during construction, and preventing moisture buildup – from inside and outside the home – after cladding is applied.

- The best defense against mold, mildew and water damage.
- Superior air holdout for better energy efficiency.
- Optimal Permeance Rating of **11.7 (Premium)**. Optimal Permeance Rating of **12-15 (Standard)**.
- Outstanding UV performance.
- Excellent surfactant resistance.
- Double-strength tear resistance.
- Easy handling and installation with STUDfinder™.
- Class 1(A) fire rating.
- Lifetime limited warranty.
- Available co-branded with your logo!



CertaTape™
available in 1-7/8" x 165'

CertaWrap™ Accessories

For maximum effectiveness, it's critical to finish your CertaWrap installation with tight sealing methods. CertaWrap accessories offer everything needed to get the job done right. Use them to seal window and door openings, cracks, seams and penetrations prior to applying exterior cladding.

CertaWrap™ Standard Housewrap

CertaWrap Standard Housewrap is a coated poly woven fabric for use in housewrap applications that controls airflow through the wall and protects against outside water from penetrating the exterior of a home. It is engineered to resist water while allowing water vapor to pass through and is stabilized to resist degradation.



CertaWrap is available in the following roll dimensions:

Premium	Standard
3' x 100'	9' x 100'
3' x 165'	
4.5' x 200'	
5' x 200'	
9' x 100'	
9' x 150'	

CertainTeed products are designed to work together and complement each other in color and style to give any home a beautiful finished look.



VINYL SIDING



POLYMER SHAKES & SHINGLES



INSULATED SIDING



METAL SIDING



ROOFING AND VENTILATION



STONE



WEATHER RESISTANT BARRIER



COMPOSITE SIDING



VINYL CARPENTRY® TRIM



PVC EXTERIOR TRIM & BEADBOARD



VINYL & METAL SOFFIT



For More Information



CertainTeed

Ceilings • Gypsum • Insulation • Roofing • Siding • Trim

20 Moores Road, Malvern, PA 19355 | 800-233-8990 | certainteed.com

©01/26 CertainTeed, Printed in the USA, Code No. 04-00-20-NA-EN